

GF SERIES

GF-200/GF-300/GF-400/GF-600/GF-800/GF-1000
GF-1200/GF-2000/GF-3000/GF-4000/GF-6100
GF-6000/GF-8000

Precision Balance

INSTRUCTION MANUAL



1WMPD4000209D

© 2014 A&D Company Ltd. All rights reserved.

No part of this publication may be reproduced, transmitted, transcribed, or translated into any language in any form by any means without the written permission of A&D Company Ltd.

The contents of this manual and the specifications of the instrument covered by this manual are subject to change for improvement without notice.

Windows, Word and Excel are registered trademarks of the Microsoft Corporation.

CONTENTS

Basic Operation

1. INTRODUCTION	3
1-1 About This Manual	3
1-2 Features	3
1-3 Compliance	4
2. UNPACKING THE BALANCE	6
2-1 Unpacking	6
2-2 Installing the Balance	7
3. PRECAUTIONS	8
3-1 Before Use	8
3-2 During Use	9
3-3 After Use	10
3-4 Power Supply	10
4. DISPLAY SYMBOLS AND KEY OPERATION	11
5. WEIGHING UNITS	12
5-1 Units	12
5-2 Storing Units	15

Adapting to the Environment

6. WEIGHING	17
6-1 Basic Operation (Gram Mode)	17
6-2 Counting Mode (PC)	18
6-3 Percent Mode (Pct)	20
7. RESPONSE ADJUSTMENT / SELF CHECK FUNCTION	21
7-1 Manual Response Adjustment	21
7-2 Self Check Function	22
8. CALIBRATION	23
8-1 Calibration Modes	23
8-2 Calibration Using an External Weight	24
8-3 Calibration Test Using an External Weight	26

Functions

9. FUNCTION SWITCH AND INITIALIZATION	28
9-1 Permit or Inhibit	28
9-2 Initializing the Balance	29
10. FUNCTION TABLE	30
10-1 Structure and Sequence of the Function Table	30
10-2 Display and Keys	30
10-3 Details of the Function Table	31
10-4 Description of the Class "Environment, Display"	34

10-5 Description of the Item "Data output mode"	36
10-6 Description of the Item "Data format"	37
10-7 Description of the Data Format Added to the Weighing Data	39
10-8 Data Format Examples	40
10-9 Comparator Function	42
11. ID NUMBER AND GLP REPORT	44
11-1 Setting the ID Number	44
11-2 GLP Report	44
12. DATA MEMORY	47
12-1 Notes on Using Data Memory	47
12-2 Memory for Weighing Data	48
12-3 Memory for Unit Mass in the Counting Mode	51
13. UNDERHOOK	52
14. PROGRAMMABLE-UNIT	53
15. DENSITY MEASUREMENT	54
 RS-232C Serial Interface	
16. RS-232C SERIAL INTERFACE / EXTERNAL INPUT	57
17. CONNECTION TO PERIPHERAL EQUIPMENT	59
17-1 Connection to the AD-8121B Printer	59
17-2 Connection to a Computer	59
17-3 Using Windows Communication Tools (WinCT)	60
18. COMMANDS	62
18-1 Command List	62
18-2 Acknowledge Code and Error Codes	63
18-3 Command Examples	64
18-4 Control Using CTS and RTS	67
18-5 Settings Related to RS-232C	67
 Maintenance	
19. MAINTENANCE	68
20. TROUBLESHOOTING	68
20-1 Checking the Balance Performance and Environment	68
20-2 Error Codes	69
20-3 Asking For Repair	71
21. SPECIFICATIONS	72
22. OPTIONS	74
23. EXTERNAL DIMENSIONS	77
24. TERMS/INDEX	78

1. INTRODUCTION

This manual describes how the GF series balance works and how to get the most out of it in terms of performance.

Read this manual thoroughly before using the balance and keep it at hand for future reference.

1-1 About This Manual

This manual consists of the following five parts:

- Basic operation.....Describes precautions on handling the balance, balance construction and basic balance operation.
- Adapting to the environment.....Describes response adjustment, calibration and calibration test.
- FunctionsDescribes various functions of the balance.
- RS-232C serial interface.....Describes the interface which transmits data and controls the balance.
- MaintenanceDescribes maintenance, error codes, troubleshooting, specifications and options.

1-2 Features

- Stabilization time of one second. When **FAST** is selected for the response rate, a stabilization time of one second, to read a displayed value after a sample is placed on the pan, has been achieved.
- Self Check Function, provided to self-check the balance.
- Data Memory Function, storing weighing data or unit mass in the counting mode. (About weighing data, 40 sets of data can be stored.) Interval Memory Mode is provided to weigh a sample and store the weighing data periodically.
- Good Laboratory Practice (GLP) data output using the standard RS-232C serial interface.
- Windows Communication Tools (WinCT), allows easy communication with Windows-based personal computer. Windows is a registered trademark of the Microsoft Corporation.
- Comparator Indicators, displaying the comparison results.
- Capacity Indicator, displaying the weight value in percentage relative to the weighing capacity.
- Hold Function, provided for weighing a moving object such as an animal.
- Underhook, for measuring density and weighing magnetic materials.
- Density Mode, for calculating the density of a solid.
- Multiple Weighing Units, with most of the common units used around the world.
- Reference Card, provided for a quick reference to the balance operation.
- Breeze Break, provided for the GF-200/300/400/600/800/1000, for more accurate weighing.

1-3 Compliance

Compliance with FCC Rules

Please note that this device generates, uses and can radiate radio frequency energy. This device has been tested and has been found to comply with the limits of a Class A computing device pursuant to Subpart J of Part 15 of FCC rules. These rules are designed to provide reasonable protection against interference when this device is operated in a commercial environment. If this unit is operated in a residential area, it may cause some interference and under these circumstances the user would be required to take, at his own expense, whatever measures are necessary to eliminate the interference.

(FCC = Federal Communications Commission in the U.S.A.)

Compliance With Directives of CE mark

CE This device features radio interference suppression, safety regulation and restriction of Hazardous Substances in compliance with the following Council Directives

Council directive 2004/108/EC EN61326 EMC directive

Council directive 2006/95/EC EN60950 Safety of Information Technology Equipment

Council directive 2011/65/EU EN50581 Restriction of the use of certain Hazardous Substances

- The CE mark is an official mandatory European marking.

Please note that any electronic product must comply with local laws and regulations when sold or used anywhere outside Europe.



A & D Instruments Ltd. hereby declare that the following Weighing product conforms to the requirements of the council directives on ...

**Electromagnetic Compatibility (EMC) 2004/108/EC,
Low Voltage Equipment (LVD) 2006/95/EC amended by 93/68/EEC and
Restriction of the use of certain Hazardous Substances (RoHS) 2011/65/EU**

provided that they bear the CE mark of conformity.

Model/Series....GF Series

Standards applicable:

EN 61326-1:2006

Electrical equipment for measurement, control and laboratory use -EMC requirements Part 1: General requirements

EN 60950-1:2006+A11:2009+A1:2010.A11:2012

Safety of Information Technology Equipment

EN 50581:2012

Technical documentation for the assessment of electrical and electronic products with respect to the restriction of hazardous substances

CE Mark first applied 11 August 2000

Signed for A&D Instruments in Oxford England 02 July 2014

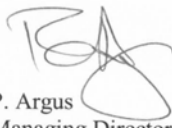

P. Argus
Managing Director

2. UNPACKING THE BALANCE

2-1 Unpacking

- The balance is a precision instrument. Unpack the balance carefully. Keep the packing material to be used for transporting the balance in the future.
- The packing contents depend on the balance model. See the illustrations to confirm that everything is contained.

GF-200/300/400/600/800/1000

How to assemble the breeze break (Only for GF-200/300/400/600/800/1000)

Assemble the breeze break as shown below.
Follow the numbered sequence.

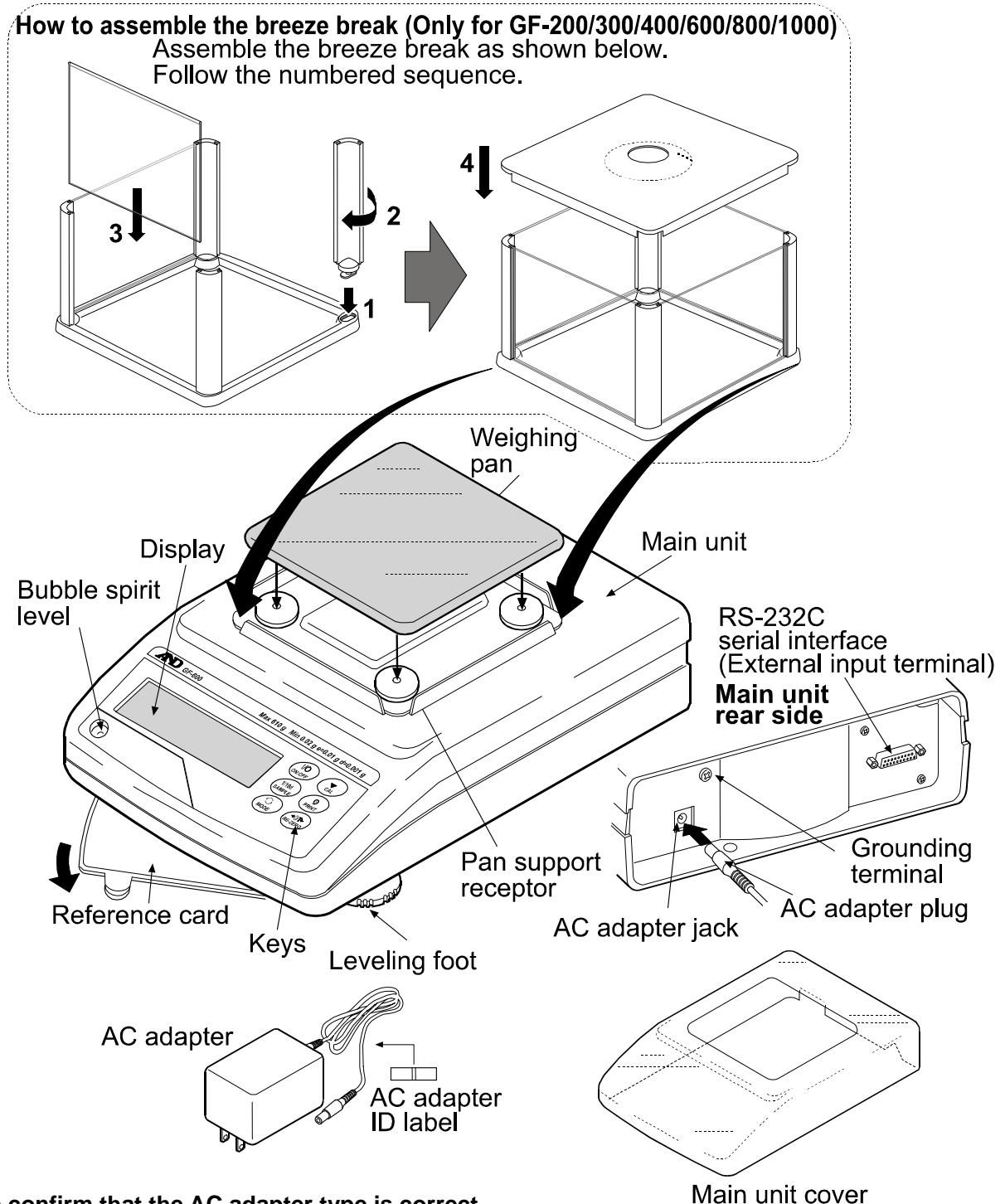

Note

Please confirm that the AC adapter type is correct for your local voltage and receptacle type.

GF-1200/2000/3000/4000/6100/6000/8000

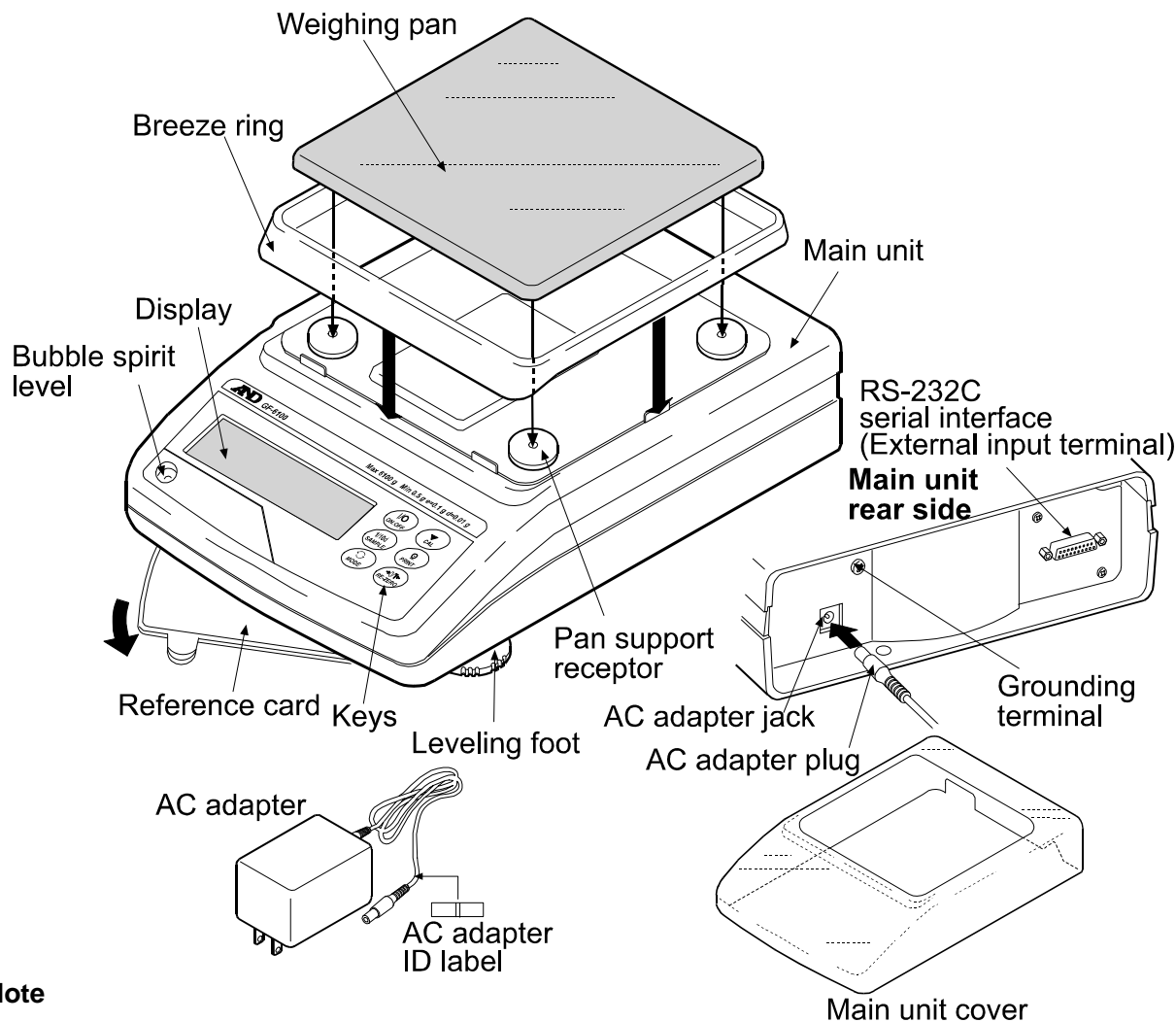

Note

Please confirm that the AC adapter type is correct for your local voltage and receptacle type.

2-2 Installing the Balance

Install the balance as follows:

1. Refer to "3. PRECAUTIONS" for installing the balance. Place the balance on a solid weighing table.
2. GF-200/300/400/600/800/1000
Assemble the breeze break on the balance as shown in the illustration on page 6.
GF-1200/2000/3000/4000/6100/6000/8000
Assemble the breeze ring and weighing pan on the balance as shown in the illustration above.
3. Adjust the leveling feet to level the balance. Confirm it using the bubble spirit level.
4. Confirm that the adapter type is correct for the local voltage and power receptacle type.
5. Connect the AC adapter to the balance. Warm up the balance for at least 30 minutes with nothing on the weighing pan.

3. PRECAUTIONS

To get the optimum performance from the balance and acquire accurate weighing data, note the following:

3-1 Before Use

- Install the balance in an environment where the temperature and humidity are not excessive. The best operating temperature is about 20°C / 68°F at about 50% relative humidity.
- Install the balance where it is not exposed to direct sunlight and it is not affected by heaters or air conditioners.
- Install the balance where it is free of dust.
- Install the balance away from equipment which produces magnetic fields.
- Install the balance in a stable place avoiding vibration and shock. Corners of rooms on the first floor are best, as they are less prone to vibration.
- The weighing table should be solid and free from vibration, drafts and as level as possible.
- Level the balance by adjusting the leveling feet and confirm it using the bubble spirit level.
- Ensure a stable power source when using the AC adapter.
- Warm up the balance for at least 30 minutes. Plug in the AC adapter as usual.
- Calibrate the balance before use or after having moved it to another location.

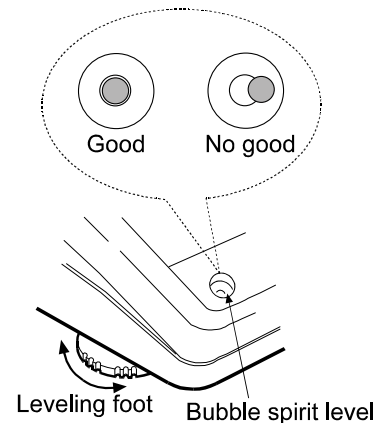

Caution

Do not install the balance where flammable or corrosive gas is present.

3-2 During Use

- Discharge static electricity from the material to be weighed (hereinafter referred to as sample). When a sample could have a static charge, the weighing data is influenced. Ground the balance and try the following:
 - Eliminate the static electricity by AD-1683 as an accessory.
 - Or try to keep the ambient humidity above 45%RH.
 - Or use a metal shield case.
 - Or wipe a charged plastic sample with the wet cloth.
- This balance uses a strong magnet as part of the balance assembly, so please use caution when weighing magnetic materials such as iron. If there is a problem, use the underhook on the bottom of the balance to suspend the material away from the influence of the magnet.
- Eliminate the temperature difference between a sample and the environment. When a sample is warmer (cooler) than the ambient temperature, the sample will be lighter (heavier) than the true weight. This error is due to a rising (falling) draft around the sample.
- Make each weighing gently and quickly to avoid errors due to changes in the environmental conditions.
- Do not drop things upon the weighing pan, or place a sample on the pan that is beyond the balance weighing capacity. Place a sample in the center of the weighing pan.
- Do not use a sharp instrument such as a pencil to press the keys. Use your finger only.
- Press the **RE-ZERO** key before each weighing to prevent possible errors.
- Calibrate the balance periodically so as to prevent possible errors.
- Take into consideration the affect of air buoyancy on a sample when more accuracy is required.
- Keep the balance interior free of dust and foreign materials.
- The breeze break (GF-200/300/400/600/800/1000 only) and the clear main unit cover are provided as accessories. The breeze break components may be charged with static electricity when they are unpacked or when the humidity is low. If the weighing value is unstable or the balance has a problem with repeatability, remove the breeze break. Or wipe the clear plates with a moistened cloth, use an accessory DC static eliminator, AD-1683, or apply an anti-static spray.

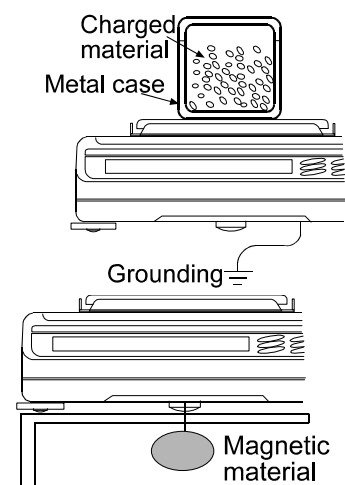

3-3 After Use

- Avoid mechanical shock to the balance.
- Do not disassemble the balance. Contact the local A&D dealer if the balance needs service or repair.
- Do not use organic solvents to clean the balance. Clean the balance with a lint free cloth that is moistened with warm water and a mild detergent.
- Avoid dust and water so that the balance weighs correctly. Protect the internal parts from liquid spills and excessive dust.

3-4 Power Supply

- When the AC adapter is connected, the balance is in the standby mode if the standby indicator is on (refer to "4. DISPLAY SYMBOLS AND KEY OPERATION"). This is a normal state and does not harm the balance. For accurate weighing, warm up the balance for at least 30 minutes before use.

4. DISPLAY SYMBOLS AND KEY OPERATION

Key operation

Key operation affects how the balance functions. The basic key operations are:

- “Press and release the key immediately” or “Press the key”
= normal key operation during measurement
- “Press and hold the key”

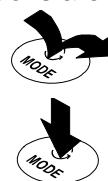

Display symbols

- Displays data stored in memory
- Displays the weighing data relative to the weighing capacity, in percentage, in the weighing mode (**Capacity indicator**)

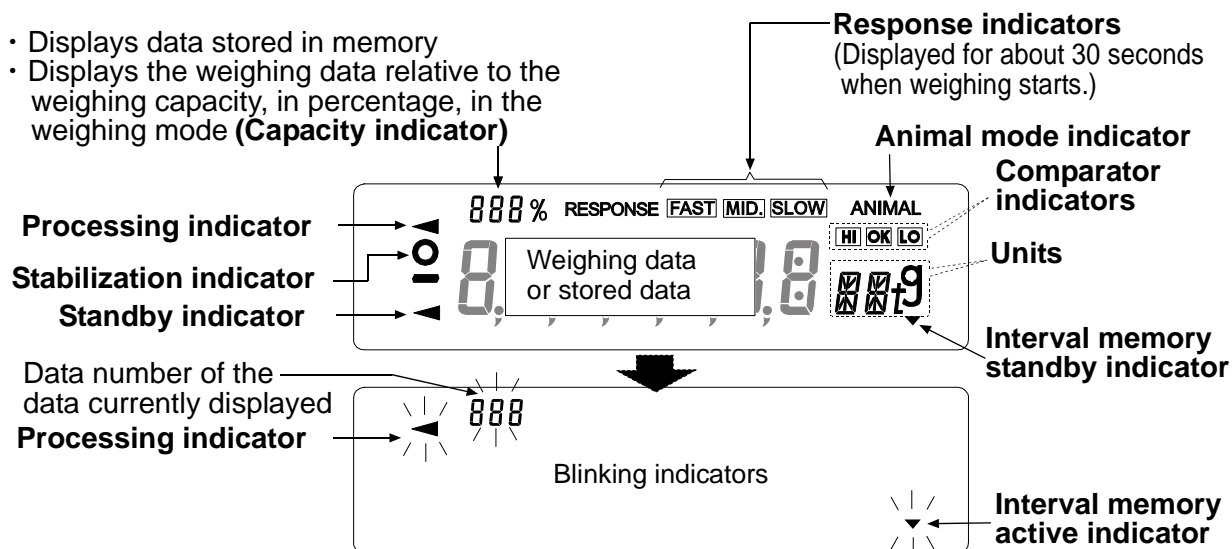

Each key, when pressed or when pressed and held, functions as follows:

Key	When pressed	When pressed and held
	Turns the display ON or OFF. The standby indicator is displayed when the display is turned off. The weighing mode is enabled when the display is turned on. This key is available anytime. Pressing the key during operation will interrupt the operation and turn the display OFF.	
	In the weighing mode, turns the minimum weighing value ON or OFF. In the counting or percent mode, enters the sample storing mode.	Enters the function table mode. Refer to “10. FUNCTION TABLE”.
	Switches the weighing units stored in the function table. Refer to “5. WEIGHING UNITS”.	Enters the response adjustment/self check mode.
	No function.	Enters the calibration mode.
	Stores the weighing data in memory or outputs to a printer or personal computer using the RS-232C interface (Factory setting), depending on the function table settings.	No function at the factory setting By changing the function table: Outputs “Title block” and “End block” for GLP report. Displays the data memory menu.
	Sets the display to zero.	

5. WEIGHING UNITS

5-1 Units

With the GF series balance, the following weighing units and weighing modes are available:

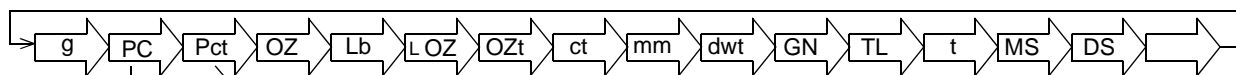

Counting mode

Percent mode

Density mode (To use this mode, it must be stored in the function table as described on page 15. For details about this mode, refer to "15. DENSITY MEASUREMENT". To select this mode, press the **MODE** key until the processing indicator blinks with the unit "g" displayed. "DS" appears only when the density value is displayed.)

Programmable-unit (No unit displayed. For details, refer to "14. PROGRAMMABLE-UNIT".)

A unit or mode can be selected and stored in the function table as described on page 15

If a weighing mode (or unit of weight) has been turned off, that mode or unit will be missing in the sequence. Tael has four varieties, one of which can be selected and installed at the factory.

To select a unit or mode for weighing, press the **MODE** key.

For details about the units and modes, see the table below:

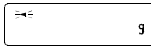
Name (unit, mode)	Abbrev.	Display	Function table (Storing mode)	Conversion factor 1 g =
Gram	g	g	g	1 g
Counting mode	PC	PC	PC	—
Percent mode	Pct	Pct	Pct	—
Ounce (Avoir)	OZ	OZ	OZ	28.349523125 g
Pound	Lb	Lb	Lb	453.59237 g
Pound/Ounce	L OZ	L OZ	LO	1Lb=16 oz, 1 oz=28.349523125 g
Troy Ounce	OZt	OZt	OZt	31.1034768 g
Metric Carat	ct	ct	ct	0.2 g
Momme	mm	mm	mm	3.75 g
Pennyweight	dwt	dwt	dwt	1.55517384 g
Grain (UK)	GN	GN	GN	0.06479891 g
Tael (HK general, Singapore)	TL	TL	TL	37.7994 g
Tael (HK jewelry)				37.429 g
Tael (Taiwan)				37.5 g
Tael (China)				31.25 g
Tola (India)	t	t	t	11.6638038 g
Messghal	MS	MS	MS	4.6875 g
Density mode (See note below)	DS	 DS is used to show the density.	DS	—
Programmable-unit (Multi-unit)	Mlt	—	MLt	—

Note: The blinking processing indicator with "g" indicates that the density mode is selected.

The tables below indicate the weighing capacity and the minimum display for each unit, depending on the balance model.

Unit	Capacity						Minimum display
	GF-200	GF-300	GF-400	GF-600	GF-800	GF-1000	
Gram	210	310	410	610	810	1100	0.001
Ounce (Avoir)	7.40	10.93	14.46	21.51	28.57	38.80	0.00005
Pound	0.462	0.683	0.903	1.344	1.785	2.425	0.000005
Pound/Ounce	0Lb 7.41oz	0Lb 10.93oz	0Lb 14.46oz	1Lb 5.52oz	1Lb 12.57oz	2Lb 6.80oz	0.01oz
Troy Ounce	6.75	9.96	13.18	19.61	26.04	35.36	0.00005
Metric Carat	1050	1550	2050	3050	4050	5500	0.005
Momme	56.0	82.6	109.3	162.6	216.0	293.3	0.0005
Pennyweight	135	199	263	392	520	707	0.001
Grain (UK)	3240	4784	6327	9413	12500	16975	0.02
Tael (HK general, Singapore)	5.55	8.20	10.84	16.13	21.42	29.10	0.00005
Tael (HK jewelry)	5.61	8.28	10.95	16.29	21.64	29.38	0.00005
Tael (Taiwan)	5.60	8.26	10.93	16.26	21.60	29.33	0.00005
Tael (China)	6.72	9.92	13.12	19.52	25.92	35.20	0.00005
Tola (India)	18.0	26.5	35.1	52.2	69.4	94.3	0.0001
Messghal	44.8	66.1	87.4	130.1	172.8	234.6	0.0005

Unit	Capacity					Minimum display
	GF-1200	GF-2000	GF-3000	GF-4000	GF-6100	
Gram	1210	2100	3100	4100	6100	0.01
Ounce (Avoir)	42.6	74.0	109.3	144.6	215.1	0.0005
Pound	2.66	4.62	6.83	9.03	13.44	0.00005
Pound/Ounce	2Lb 10.68oz	4Lb 10.08oz	6Lb 13.35oz	9Lb 0.62oz	13Lb 7.17oz	0.01oz
Troy Ounce	38.9	67.5	99.6	131.8	196.1	0.0005
Metric Carat	6050	10500	15500	20500	30500	0.05
Momme	322	560	826	1093	1626	0.005
Pennyweight	778	1350	1993	2636	3922	0.01
Grain (UK)	18673	32408	47840	63272	94137	0.2
Tael (HK general, Singapore)	32.0	55.5	82.0	108.4	161.3	0.0005
Tael (HK jewelry)	32.3	56.1	82.8	109.5	162.9	0.0005
Tael (Taiwan)	32.2	56.0	82.6	109.3	162.6	0.0005
Tael (China)	38.7	67.2	99.2	131.2	195.2	0.0005
Tola (India)	103	180	265	351	522	0.001
Messghal	258	448	661	874	1301	0.005

Unit	Capacity		Minimum display
	GF-6000	GF-8000	
Gram	6100	8100	0.1
Ounce (Avoir)	215	285	0.005
Pound	13.4	17.8	0.0005
Pound/Ounce	13Lb 7.17oz	17Lb 13.72oz	0.01oz
Troy Ounce	196	260	0.005
Metric Carat	30500	40500	0.5
Momme	1626	2160	0.05
Pennyweight	3922	5208	0.1
Grain (UK)	94136	125002	2
Tael (HK general, Singapore)	161	214	0.005
Tael (HK jewelry)	162	216	0.005
Tael (Taiwan)	162	216	0.005
Tael (China)	195	259	0.005
Tola (India)	522	694	0.01
Messghal	1301	1728	0.05

5-2 Storing Units

The units or modes can be selected and stored in the function table. The sequence of displaying the units or modes can be arranged to fit the frequency of use.

The units stored are maintained in non-volatile memory, even if the AC adapter is removed.

Select a unit or mode and arrange the sequence of display as follows:

1 Press and hold the **SAMPLE** key until **bRSFnC** of the function table is displayed, then release the key.

2 Press the **SAMPLE** key several times to display **Unit**.

3 Press the **PRINT** key to enter the unit selection mode.

4 Specify a unit or mode in the order to be displayed using the following keys.

- | | |
|--------------------|--|
| SAMPLE key | To sequentially display the units. |
| RE-ZERO key | To specify a unit or mode. The stabilization indicator  appears when the displayed unit or mode is specified. |

5 Press the **PRINT** key to store the units or modes. The balance displays **End** and then displays the next menu of the function table.

6 Press the **CAL** key to exit the function table. Then the balance returns to the weighing mode with the selected unit.

7 To select other unit or mode for weighing, press the **MODE** key.

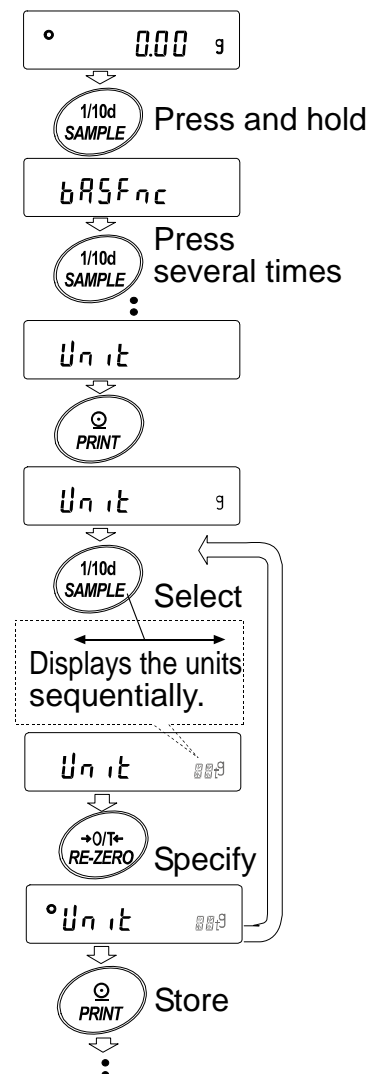

Unit setting example

The example below sets the units in the order with g (gram) as the first unit followed by pc (counting mode).

- 1 Press and hold the **SAMPLE** key until **bRSFnC** of the function table is displayed, then release the key.
- 2 Press the **SAMPLE** key several times to display **Unit**.
- 3 Press the **PRINT** key to enter the unit selection mode.
- 4 Press the **RE-ZERO** key to specify the unit of g
The stabilization indicator **◦** appears when the unit is specified.
- 5 Press the **SAMPLE** key to display **Unit PC**.
- 6 Press the **RE-ZERO** key to specify the unit of pc
The stabilization indicator **◦** appears when the unit is specified.
- 7 Press the **PRINT** key to store the units.
The balance displays **End** and then displays the next menu item of the function table.
- 8 Press the **CAL** key to exit the function table. Then the balance returns to the weighing mode with g, the unit selected first.
- 9 Press the **MODE** key to switch between g and pc (g→pc).

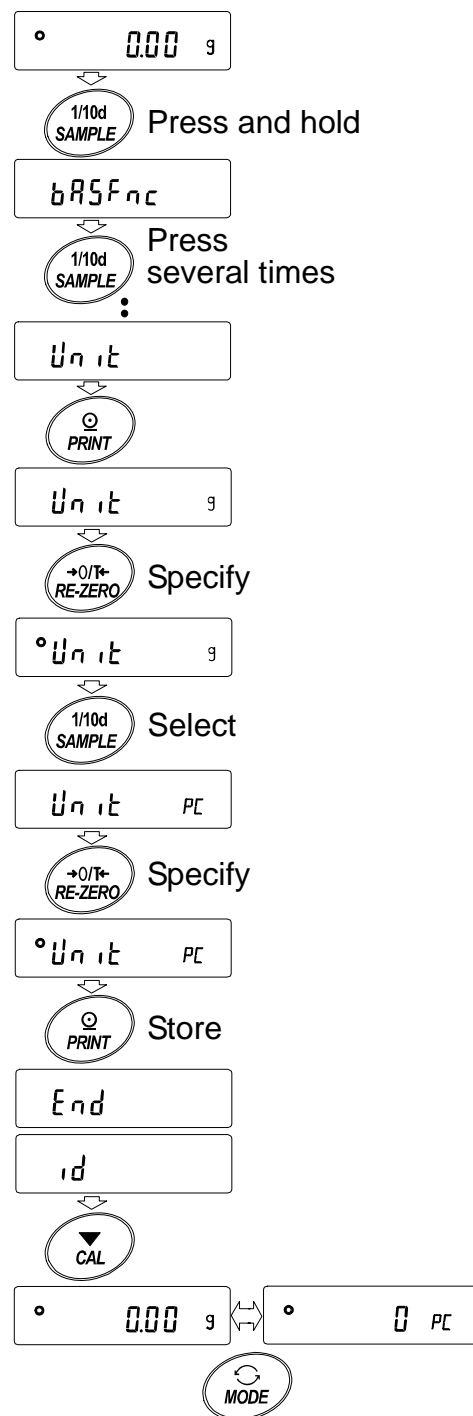

6. WEIGHING

6-1 Basic Operation (Gram Mode)

- 1 Place a container on the weighing pan, if necessary.
Press the **RE-ZERO** key to cancel the weight (tare). The balance displays **0.00 g**. (The decimal point position depends on the balance model.)
- 2 Place a sample on the pan or in the container.
- 3 Wait for the stabilization indicator **◦** to be displayed.
Read the value.
- 4 Remove the sample and container from the pan.

Notes

- To use other units, press the **MODE** key and select an appropriate unit.
- Press the **SAMPLE** key to turn ON or OFF the minimum weighing value.
- The weighing data can be stored in memory. For details, refer to “12. DATA MEMORY”.

When the **ON:OFF** key is pressed with a container placed on the weighing pan and weighing is started, the balance automatically cancels the weight (tare) and displays **0.00 g**.

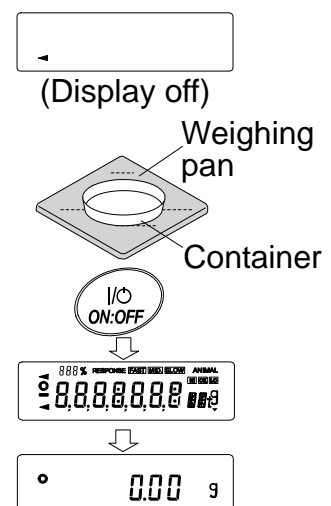
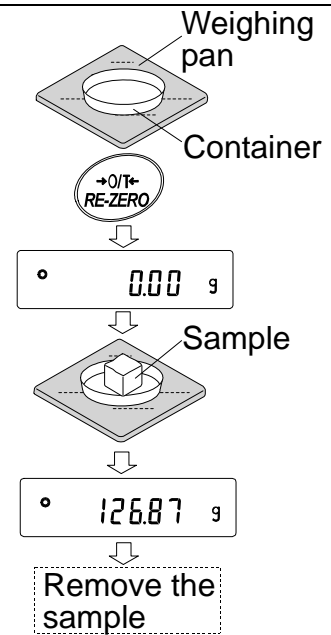

6-2 Counting Mode (PC)

This is the mode to determine the number of objects in a sample based on the standard sample unit mass. Unit mass means the mass of one sample. The smaller the variables in each sample unit mass is, the more accurate the counting will be. The GF series balance is equipped with the Automatic Counting Accuracy Improvement (ACAI) function to improve the counting accuracy.

Notes

- For counting, use samples that have a unit mass at least ten times greater than that of the minimum display in grams.
- If the sample unit mass variable is too large, it may cause a counting error.
- To improve the counting performance, use the ACAI function frequently or divide the samples into several groups and count each group.

Selecting the counting mode

- 1 Press the **MODE** key to select **PC** (counting mode).

Storing a sample unit mass

- 2 Press the **SAMPLE** key to enter the sample unit mass storing mode.

Even in the storing mode, pressing the **MODE** key will switch to the next mode.

- 3 To select the number of samples, press the **SAMPLE** key several times. It may be set to 10, 25, 50 or 100.

Note

A greater number of samples will yield more accurate counting result.

- 4 Place a container on the weighing pan, if necessary. Press the **RE-ZERO** key to cancel the weight (tare). The number specified in step 3 appears.

e.g.: **25 0 PC** is displayed if 25 is selected in step 3.

- 5 Place the number of samples specified on the pan. In this example, 25 pieces.

- 6 Wait for the stabilization indicator **○** to be displayed. Press the **PRINT** key to calculate and store the unit mass. The balance displays **25 PC** (counting mode) and is set to count samples with this unit mass. (The sample unit mass is stored in non-volatile memory, and is maintained even if the AC adapter is removed.)

To improve the accuracy of the unit mass, proceed to step 8.

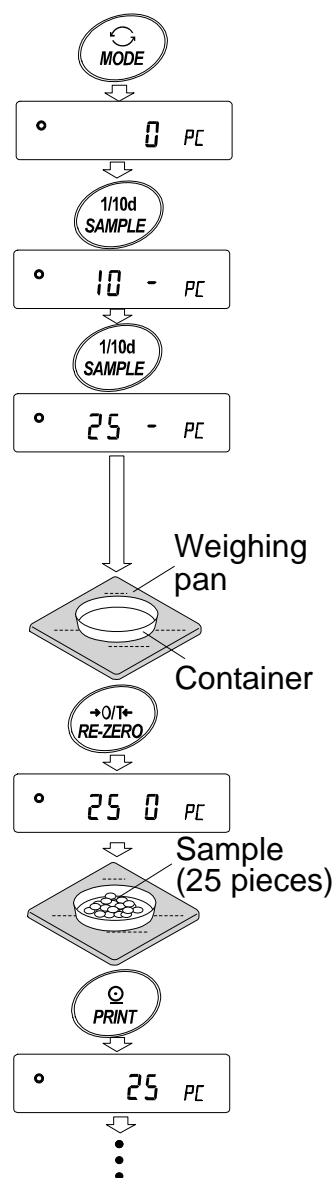

Notes

- If the balance judges that the mass of the samples is too light and is not adequate to be used as the unit mass, it displays **Lo**.
- If the balance judges that the mass of the samples is too light to acquire accurate weighing, it displays an error requiring the addition of more samples to the specified number. In the example above, **50- PC** appears, requiring 25 more samples. Add 25 samples and press the **PRINT** key. When the unit mass is stored correctly, the balance proceeds to the counting mode.

Counting operation

- 7 Place the samples to be counted on the pan.

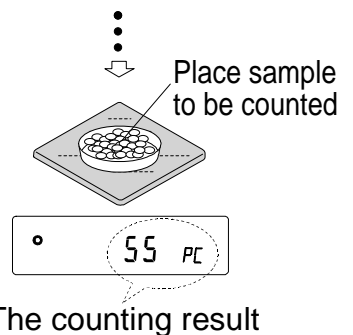

Note

Up to 20 unit masses can be stored in memory for the multiple sample. For details, refer to "12. DATA MEMORY". The unit mass data in memory can be recalled or changed using commands from the computer.

Counting mode using the ACAI function

The ACAI is a function that improves the accuracy of the unit mass automatically by increasing the number of samples as the counting process proceeds.

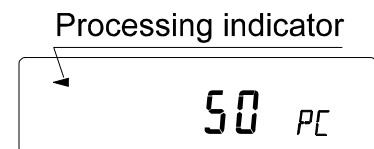

- 8 If a few more samples are added, the processing indicator turns on. To prevent an error, add three or more. The processing indicator does not turn on if overloaded. Try to add the same number of samples as displayed.
- 9 The balance re-calculates the unit mass while the processing indicator is blinking. Do not touch the balance or samples on the pan until the processing indicator turns off.
- 10 Counting accuracy is improved when the processing indicator turns off.
Each time the above operation is performed, a more accurate unit mass will be obtained. There is no definite upper limit of ACAI range for the number of samples exceeding 100. Try to add the same number of samples as displayed.
- 11 Remove all the samples used in ACAI and proceed with the counting operation using the improved unit mass.

6-3 Percent Mode (Pct)

This is the mode to display the weight value in percentage compared to a 100% reference mass and is used for target weighing or checking the sample variable.

Selecting the percent mode

- 1 Press the **MODE** key to select **Pct** (percent mode). If the percent mode can not be selected, refer to “5. WEIGHING UNITS”.

Storing the 100% reference mass

- 2 Press the **SAMPLE** key to enter the 100% reference mass storing mode.

Even in the storing mode, pressing the **MODE** key will switch to the next mode.

- 3 Place a container on the weighing pan, if necessary. Press the **RE-ZERO** key to cancel the weight (tare). The balance displays **100 0 Pct**.

- 4 Place the sample to be set as the 100% reference mass on the pan or in the container.

- 5 Press the **PRINT** key to store the reference mass. The balance displays **10000 Pct**. (The decimal point position depends on the reference value. The reference mass is stored in non-volatile memory, and is maintained even if the AC adapter is removed.)

Note

If the balance judges that the mass of the sample is too light to be used as a reference, it displays **Lo**.

- 6 Remove the sample.

Reading the percentage

- 7 Place a sample to be compared to the reference mass on the pan. The displayed percentage is based on the 100% reference mass.

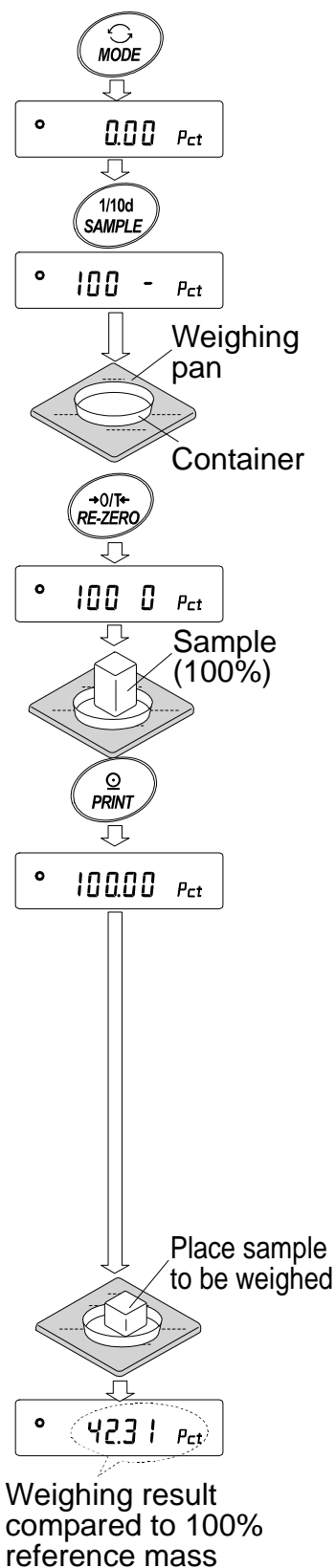

7. RESPONSE ADJUSTMENT / SELF CHECK FUNCTION

7-1 Manual Response Adjustment

The function has three rates as follows:

Response indicators



Changing the response rate changes the display refresh rate.

Indicator	Parameter	Response characteristic	Display refresh rate
FAST	[<i>ond 0</i>]	Fast response, Sensitive value ↑ ↓	If the response rate is changed as follows: MID. or SLOW → FAST = 10 times/second FAST → MID. or SLOW = 5 times/second
MID.	[<i>ond 1</i>]		
SLOW	[<i>ond 2</i>]		

Note

To set the refresh rate of 5 times/second when the response rate is FAST or 10 times/second when the response rate is MID. or SLOW, change the “Display refresh rate (*SPd*)” parameter of “Environment, Display (*bR5Fnc*)” in the function table. For details, refer to “10. FUNCTION TABLE”.

To increase the response rate, or to obtain a more stable display, perform the following:

Operation

- 1 Press and hold the **MODE** key until **RESPONSE** is displayed, then release the key.

Press the **MODE** key again quickly.

- 2 Press the **MODE** key to select a rate of the response adjustment. Either **FAST**, **MID.** or **SLOW** can be selected.

- 3 After a few seconds of inactivity the balance displays [*End*]. Then, it returns to the weighing mode and displays the updated response indicator. The response indicator remains displayed for about 30 seconds.

Note

The response adjustment can be changed at “Condition (*Cond*)” of “Environment, Display (*bR5Fnc*)” in the function table. For details, refer to “10. FUNCTION TABLE”.

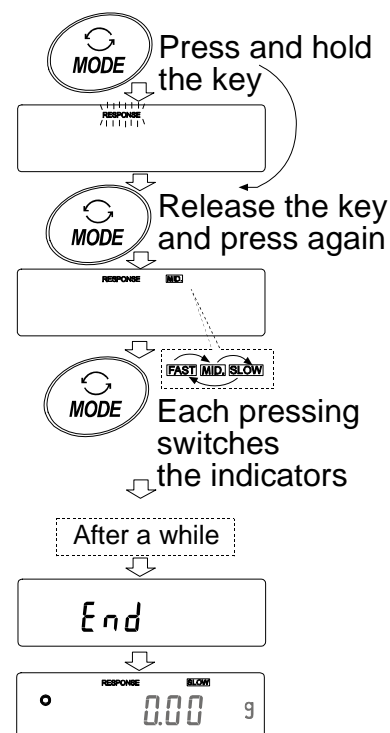

7-2 Self Check Function

This function self-checks the internal performance of the balance.

Operation

- 1 Press and hold the **MODE** key until **RESPONSE** is displayed, then release the key.
- 2 The balance automatically starts to check its internal performance
- 3 After self-check, the balance displays the checking result and returns to the weighing mode.

e.g. "OK"

The example above indicates that the result of the self check is good.

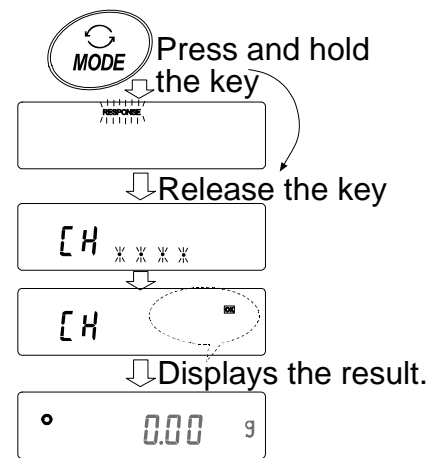

Note

If improper performance is found in the self check, the balance displays **[H nD**. Contact the local A&D dealer for repair.

8. CALIBRATION

8-1 Calibration Modes

The GF series balance has the following two modes.

- Calibration using an external weight
- Calibration test using an external weight (Calibration test does not perform calibration.)

Terms

The following terms are defined as follows:

External weight = A weight that you have. Referred to as a calibration weight when used for calibration.

Calibration weight = A weight used for calibration

Target weight = An external weight used for calibration test

Caution

- Calibration adjusts the balance for accurate weighing.
Besides periodic calibration and before each use, perform calibration when:
 - the balance is installed for the first time.
 - the balance has been moved.
 - the ambient environment has changed.
- Do not allow vibration or drafts to affect the balance during calibration.
- To output the data for GLP using the RS-232C interface, set "GLP output (*info*)" of "Data output (*dout*)". For details, refer to "10. FUNCTION TABLE".
- Calibration test is available only when "GLP output (*info*)" of "Data output (*dout*)" is set to "1" or "2",

Caution on using an external weight

- The accuracy of an external weight can influence the accuracy of weighing. Select an appropriate weight as listed below:

Model	Usable calibration weight	Adjustable range
GF-200	200 g , 100 g	-0.015 g to +0.015 g
GF-300	300 g, 200 g , 100 g	
GF-400	400 g , 300 g, 200 g	
GF-600	600 g, 500 g , 400 g, 300 g, 200 g	
GF-800	800 g, 700 g, 600 g, 500 g , 400 g, 300 g, 200 g	
GF-1000	1000 g , 900 g, 800 g, 700 g, 600 g, 500 g, 400 g, 300 g, 200 g	
GF-1200	1000 g , 500 g	-0.15 g to +0.15 g
GF-2000	2000 g , 1000 g	
GF-3000	3000 g, 2000 g , 1000 g	
GF-4000	4000 g , 3000 g, 2000 g	
GF-6100	6000 g, 5000 g , 4000 g, 3000 g, 2000 g	
GF-6000	6000 g, 5000 g , 4000 g, 3000 g, 2000 g	-1.5 g to +1.5 g
GF-8000	8000 g, 7000 g, 6000 g, 5000 g , 4000 g, 3000 g, 2000 g	

The calibration weight in bold type: factory setting

The calibration weight value can be adjusted within the range above.

Display



- This indicator means "the balance is measuring calibration data". Do not allow vibration or drafts to affect the balance while this indicator is displayed.

8-2 Calibration Using an External Weight

This function calibrates the balance using an external weight.

Operation

- 1 Connect the AC adapter and warm up the balance for at least 30 minutes with nothing on the pan.
- 2 Press and hold the **CAL** key until **[CALout]** is displayed, and then release the key.
- 3 The balance displays **[CAL 0]**.
 - If you want to change the calibration weight (a list of usable weights is shown on page 23), press the **SAMPLE** key and proceed to step 4.
 - If you use the calibration weight value stored in the balance, proceed to step 5.
- 4 Specify the calibration weight value as follows:

SAMPLE key To switch the display condition to: "All of the segments blinking" (calibration weight selection mode) or "The last two digits blinking" (value adjustment mode).

RE-ZERO key To select the calibration weight or adjust the value. In the value adjustment mode, -15 digits appear after +15 digits.

PRINT key To store the new weight value. Even if the AC adapter is removed, the data is maintained in non-volatile memory.

CAL key To cancel the operation and return to **[CAL 0]**.

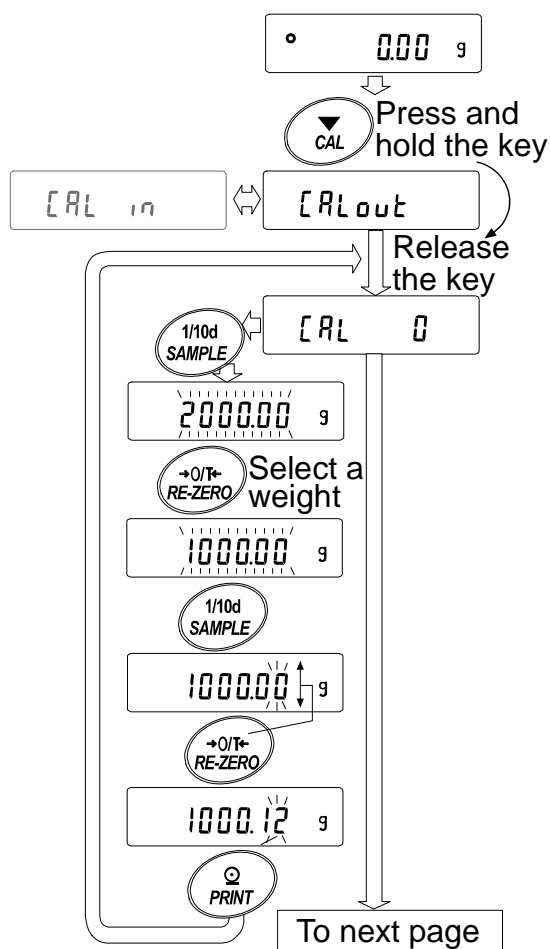

e.g. Calibration weight value
1000.12 g

Note

Digit, when used for the GF series balance, indicates a unit of minimum weighing value.

- Confirm that there is nothing on the pan and press the **PRINT** key. The balance measures the zero point. Do not allow vibration or drafts to affect the balance.

The balance displays the calibration weight value.

- Place the displayed calibration weight on the pan and press the **PRINT** key. The balance measures the calibration weight. Do not allow vibration or drafts to affect the balance.

- The balance displays **End**. Remove the weight from the pan.

- If the “GLP output (inF0)” parameter, of the function table, is set to “1” or “2”, the balance displays **GLP** and outputs “Calibration Report” using the RS-232C interface or stores the data in memory. For details on the calibration report format, refer to “11-2 GLP Report”.

- The balance will automatically return to the weighing mode.

- Place the calibration weight on the pan and confirm that the value displayed is within ± 2 digits of the specified value. If it is not within the range, check the ambient conditions such as breeze and vibration, also check the weighing pan. Then, repeat steps 1 to 10.

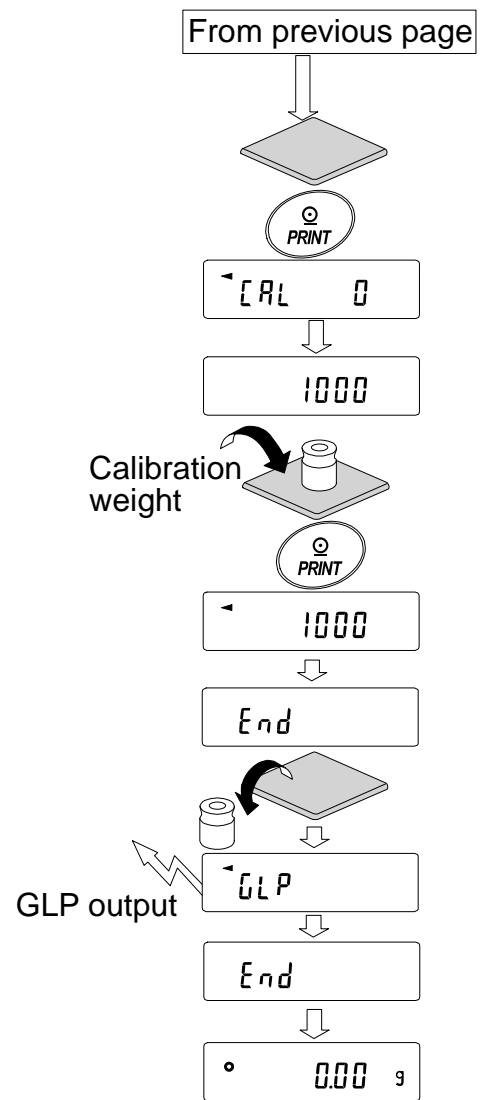

8-3 Calibration Test Using an External Weight

This function tests the balance weighing accuracy using an external mass and outputs the result. This is available only when the “GLP output (INF0)” parameter is set to “1” or “2”. (Calibration test does not perform calibration.)

Operation

- 1 Connect the AC adapter and warm up the balance for at least 30 minutes with nothing on the pan.
- 2 Press and hold the **CAL** key until **[[out** is displayed, then release the key.

- 3 The balance displays **[[0**.
 - If you want to change the target weight (a list of usable weights is shown on page 23), press the **SAMPLE** key and proceed to step 4.
 - If you use the target weight value stored in the balance, proceed to step 5.

- 4 Specify the target weight value as follows:

SAMPLE key To switch the display condition to: “All of the segments blinking” (target weight selection mode) or “The last two digits blinking” (value adjustment mode).

RE-ZERO key To select the target weight or adjust the value. In the value adjustment mode, -15 digits appear after +15 digits.

PRINT key To store the new weight value. Even if the AC adapter is removed, the data is maintained in non-volatile memory.

CAL key To cancel the operation and return to **[[0**.

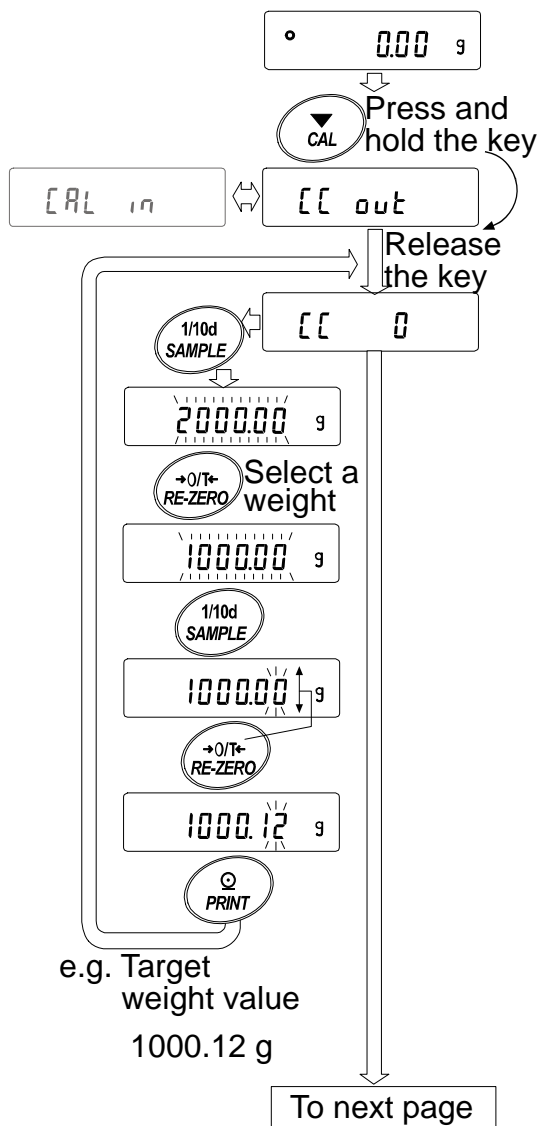

Note

Digit, when used for the GF series balance, indicates a unit of minimum weighing value.

- 5 Confirm that there is nothing on the pan and press the **PRINT** key. The balance measures the zero point and displays the measured value. Do not allow vibration or drafts to affect the balance.
- The balance displays the target weight value.

- 6 Place the displayed target weight on the pan and press the **PRINT** key. The balance measures the target weight and displays the measured value. Do not allow vibration or drafts to affect the balance.

- 7 The balance displays **End**. Remove the weight from the pan.

- 8 The balance displays **GLP** and outputs “Calibration Test Report” using the RS-232C interface or stores the calibration test data in memory. For details on the calibration test report format, refer to “11-2 GLP Report”.

- 9 The balance will automatically return to the weighing mode.

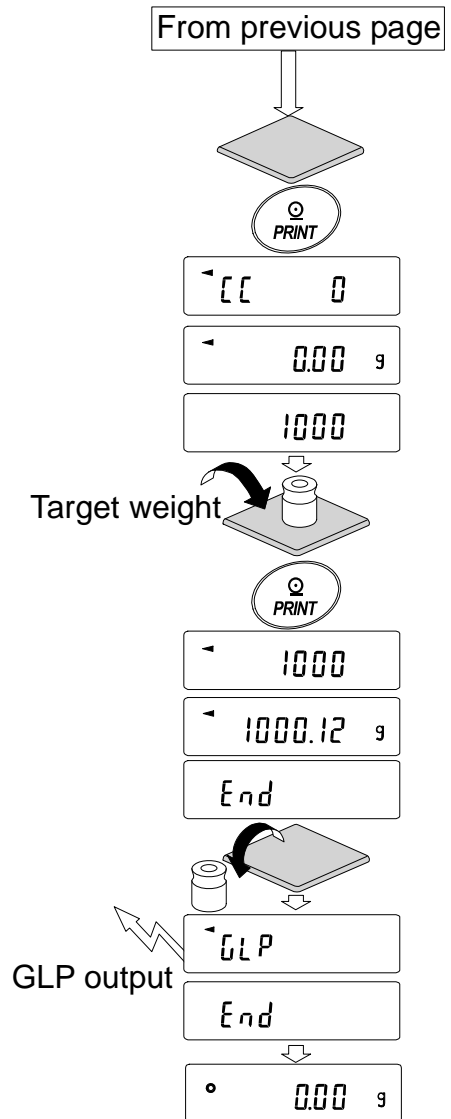

9. FUNCTION SWITCH AND INITIALIZATION

9-1 Permit or Inhibit

The balance stores parameters that must not be changed unintentionally (e.g. Calibration data for accurate weighing, Data for adapting to the operating environment, Control data for the RS-232C interface). There are five switches for the purpose of protecting these parameters. Each switch can select either “permit” or “inhibit”. “Inhibit” protects parameters against unintentional operations.

Switches

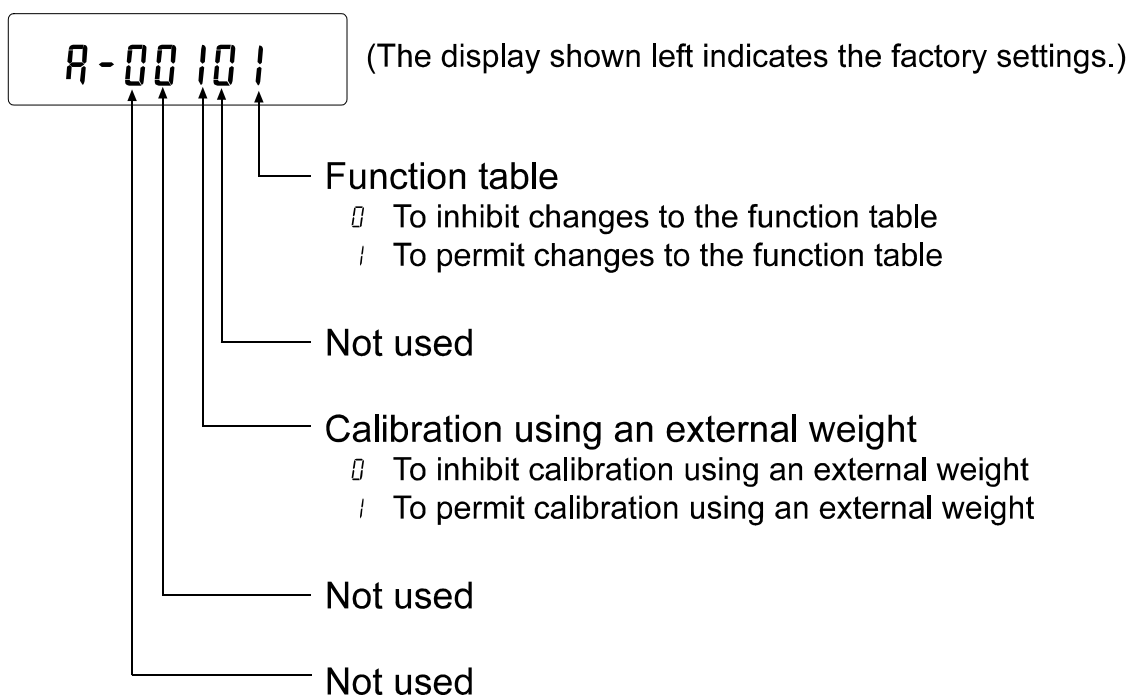

Operation

- 1 Press the **ON:OFF** key to turn off the display.
- 2 While pressing and holding the **PRINT** key and the **SAMPLE** key, press the **ON:OFF** key. The balance displays **P5**.
- 3 Press the **PRINT** key. Then the balance displays the function switches.
- 4 Set the switches using the following keys.
 - SAMPLE** key To select the switch to change the parameter.
 - RE-ZERO** key To change the parameter of the switch selected.
0: To inhibit changes. 1: To permit changes
 - PRINT** key To store the new parameter and return to the weighing mode.
 - CAL** key To cancel the operation (**ELr** is displayed.) To return to the weighing mode, press the **CAL** key once again.

9-2 Initializing the Balance

This function returns the following parameters to factory settings.

- Calibration data
- Function table
- The sample unit mass value (counting mode), 100% reference mass value (percent mode)
- The data that is stored in the balance using the data memory function
- External calibration weight and target weight value
- Function switch settings
- Liquid density and temperature in the density mode

Note

Be sure to calibrate the balance after initialization.

Operation

- 1 Press the **ON:OFF** key to turn off the display.
- 2 While pressing and holding the **PRINT** key and the **SAMPLE** key, press the **ON:OFF** key. The balance displays **P5**.
- 3 Press the **SAMPLE** key to display **[Lr**.
- 4 Press the **PRINT** key.
To cancel this operation, press the **CAL** key.
- 5 Press the **RE-ZERO** key.
- 6 Press the **PRINT** key to initialize the balance.
The balance will automatically return to the weighing mode.

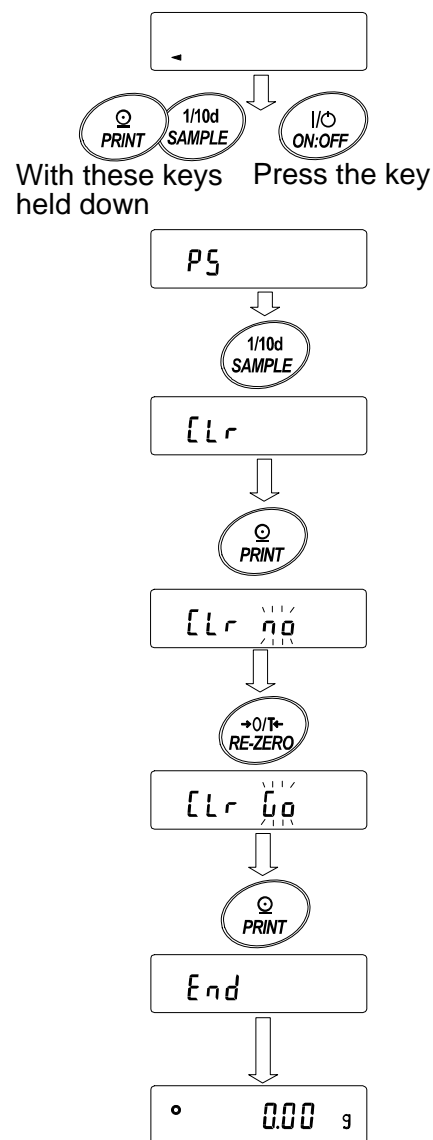

10. FUNCTION TABLE

The function table reads or rewrites the parameters that are stored in the balance. These parameters are stored in non-volatile memory, and are maintained even if the AC adapter is removed..

10-1 Structure and Sequence of the Function Table

The function table menu consists of two layers. The first layer is the “Class” and the second layer is the “Item”. Each item stores a parameter.

Example

This example sets “Stores weighing data” for “Data memory” and “Every 1 minute” for “Interval time”.

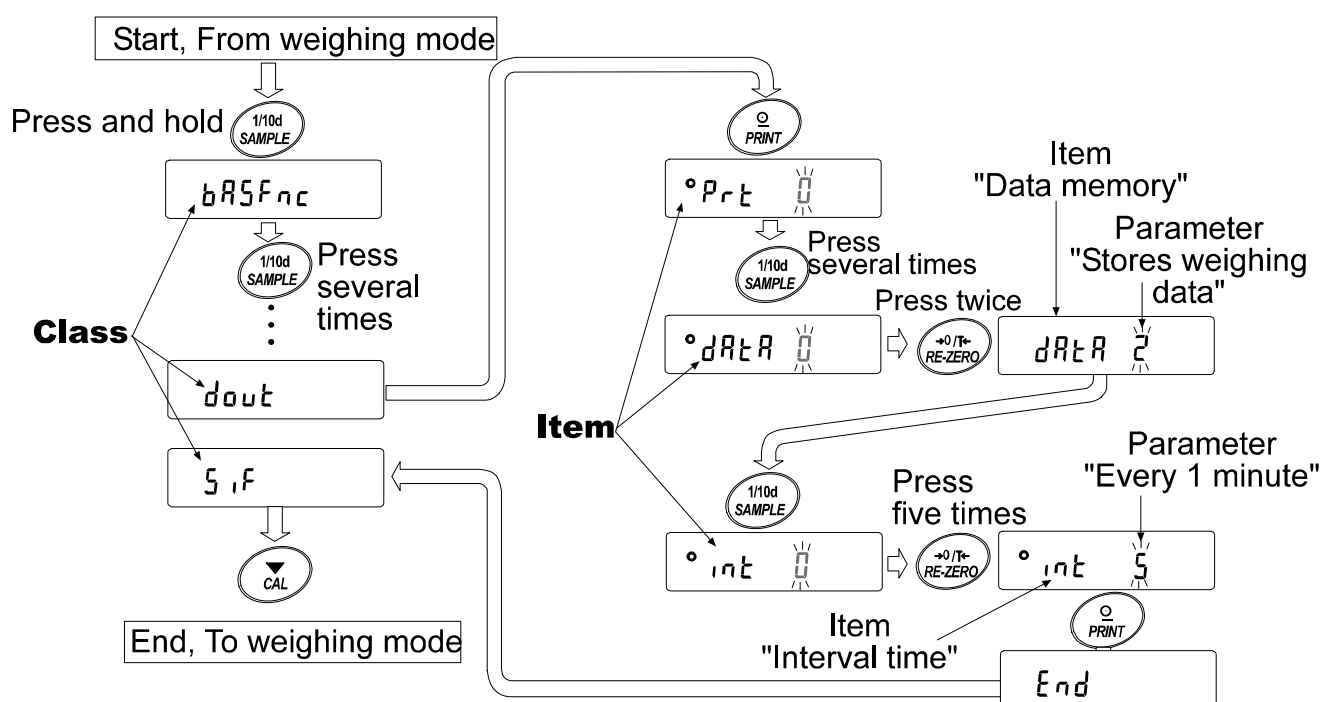

10-2 Display and Keys

Display/Key	Description
°	The symbol “°” indicates that the parameter displayed is in effect.
1/10d SAMPLE	When pressed and held in the weighing mode, enters the function table mode. Selects the class or item in the function table mode.
→0/T← RE-ZERO	Changes the parameter.
○ PRINT	When a class is displayed, moves to an item in the class. When an item is displayed, stores the new parameter and displays the next class.
▼ CAL	When an item is displayed, cancels the new parameter and displays the next class. When a class is displayed, exits the function table mode and returns to the weighing mode.

10-3 Details of the Function Table

Class	Item	Parameter	Description
bRSFnC Environment Display	Cond Condition	0	Fast response, sensitive value [FAST]
		1	↕
		2	Slow response, stable value [SLOW]
	St-b Stability band width	0	Stable when within ± 1 digit
		1	↕
		2	Stable when within ± 3 digits
	Hold Hold function	0	OFF
		1	ON
	ErrC Zero tracking	0	OFF
		1	Normal
2		Strong	
3		Very strong	
SPd Display refresh rate	0	5 times/second	
	1	10 times/second	
Pnt Decimal point	0	Point (.)	
	1	Comma (,)	
P-on Auto display-ON	0	OFF	
	1	ON	
P-off Auto display-OFF	0	OFF	
	1	ON (10 minutes)	
CSI Capacity indicator	0	OFF	
	1	ON	
CPFnC Comparator	CP Comparator mode	0	No comparison
		1	Comparison, excluding "near zero" when stable value or overloaded
		2	Comparison, including "near zero" when stable value or overloaded
		3	Continuous comparison, excluding "near zero"
	4	Continuous comparison, including "near zero"	
CPin Input method	0	Digital input, upper/lower limits	
	1	Weighing input, upper/lower limits	
	2	Digital input, reference value	
3	Weighing input, reference value		
CPHi Upper limit	See "10-9 Comparator Function"		Displayed when CPin 0 or CPin 1 is selected.
CPLo Lower limit	See "10-9 Comparator Function"		Displayed when CPin 2 or CPin 3 is selected.
CPref Reference value	See "10-9 Comparator Function"		Displayed when CPin 2 or CPin 3 is selected.
CPLnt Tolerance	See "10-9 Comparator Function"		Displayed when CPin 2 or CPin 3 is selected.

▪ Factory setting **Note:** "Digit" is a unit of minimum weighing value.

Class	Item	Parameter	Description	
<i>dout</i> Data output	<i>Prt</i> Data output mode	0	Key mode	Accepts the PRINT key only when the display is stable.
		1	Auto print mode A (Reference = zero)	Outputs data when the display is stable and conditions of <i>AP-P</i> , <i>AP-b</i> and the reference value are met.
		2	Auto print mode B (Reference = last stable value)	
		3	Stream mode / Interval memory mode	With <i>dARA</i> 0, outputs data continuously; with <i>dARA</i> 2, uses interval memory.
	<i>AP-P</i> Auto print polarity	0	Plus only	Displayed value > Reference
		1	Minus only	Displayed value < Reference
		2	Both	Regardless of displayed value
	<i>AP-b</i> Auto print difference	0	10 digits	Difference between reference value and displayed value
		1	100 digits	
		2	1000 digits	
	<i>dARA</i> Data memory	0	Not used	Related items: <i>Prt</i> , <i>int</i> , <i>d-no</i>
		1	Stores unit mass in counting mode	
		2	Stores weighing data	
	<i>int</i> Interval time	0	Every measurement	Interval time in the interval memory mode (with <i>Prt</i> 3, <i>dARA</i> 2)
		1	Every 2 seconds	
		2	Every 5 seconds	
		3	Every 10 seconds	
		4	Every 30 seconds	
		5	Every 1 minute	
		6	Every 2 minutes	
		8	Every 10 minutes	
	<i>d-no</i> Data number output	0	No output	See "12. DATA MEMORY".
		1	Output	
	<i>S-ID</i> ID number output	0	No output	Selects whether or not the ID number is output.
		1	Output	
	<i>PUSE</i> Data output pause	0	No pause	Selects the data output interval.
		1	Pause (1.6 seconds)	
<i>At-F</i> Auto feed	0	Not used	Selects whether or not auto feed is performed.	
	1	Used		
<i>inFo</i> GLP output	0	No output	Selects GLP output method.	
	1	AD-8121 format		
	2	General data format		
<i>Ar-d</i> Zero after output	0	Not used	Adjusts zero automatically after data is output.	
	1	Used		

■ Factory setting

Class	Item	Parameter	Description		
51F Serial interface	bPS Baud rate	0	600 bps		
		1	1200 bps		
		▪ 2	2400 bps		
		3	4800 bps		
		4	9600 bps		
	bPr Data bit, parity bit	▪ 0	7 bits, even		
		1	7 bits, odd		
		2	8 bits, none		
	CrLF Terminator	▪ 0	CR LF	CR: ASCII code 0Dh	
		1	CR	LF: ASCII code 0Ah	
	tYPE Data format	▪ 0	A&D standard format		
		1	DP format		See "10-6 Description of Item "Data Format".
		2	KF format		
		3	MT format		
		4	NU format		
	5	CSV format			
t-UP Timeout	0	No limit		Selects the wait time to receive a command.	
	▪ 1	1 second			
ErCd AK, Error code	▪ 0	No output		AK: ASCII code 06h	
	1	Output			
CrS CTS, RTS control	▪ 0	Not used		Controls CTS and RTS.	
	1	Used			
d5 Fnc Density function	Ldin Liquid density input	▪ 0	Water temperature	Available only when density mode is selected. See "15. DENSITY MEASUREMENT".	
		1	Liquid density		
nLt Programmable-unit (Multi-unit)			Sets an arbitrary coefficient. See "14. PROGRAMMABLE-UNIT".	Available only when programmable-unit mode is selected.	
Unit Unit			See "5. WEIGHING UNITS".		
id ID number setting			See "11. ID NUMBER AND GLP REPORT".		

▪ Factory setting

Caution

The balance may not transmit the data completely at the specified refresh rate, depending on the baud rate or data added to the weighing data such as ID number.

10-4 Description of the Class “Environment, Display”

Condition ($Cond$)

$Cond\ 0$



$Cond\ 2$

This parameter is for sensitive response to the fluctuation of a weight value. Used for powder target weighing, weighing a very light sample or when quick response weighing is required.

After setting, the balance displays **FAST**.

This parameter is for stable weighing with slow response. Used to prevent a weight value from drifting due to vibration or drafts.

After setting, the balance displays **SLOW**.

Note

With “Hold function ($Hold$)” set to “ON (1)”, this item is used to set the averaging time.

Stability band width ($St-b$)

This item controls the width to regard a weight value as a stable value. When the fluctuation per second is less than the parameter, the balance displays the stabilization indicator and outputs or stores the data. The parameter influences the “Auto print mode”

$St-b\ 0$



$St-b\ 2$

This parameter is for sensitive response of the stabilization indicator. Used for exact weighing.

This parameter ignores slight fluctuation of a weight value. Used to prevent a weight value from drifting due to vibration or drafts.

Note

With “Hold function ($Hold$)” set to “ON (1)”, this item is used to set the stabilization range.

Hold function ($Hold$) (Animal weighing mode)

This function is used to weigh a moving object such as an animal.

When the weighing data is over the weighing range from zero and the display fluctuation is within the stabilization range for a fixed period of averaging time, the processing indicator illuminates and the balance displays the average weight of the animal. When the animal is removed from the weighing pan, the display returns to zero automatically.

This function is available only when the hold function parameter is set to “ 1 ” (the animal mode indicator **ANIMAL** illuminates) and any weighing unit other than the counting mode is selected.

Weighing range	
GF-200/300/400/600/800/1000	0.200 g or over
GF-1200/2000/3000/4000/6100	2.00 g or over
GF-6000/8000	10.0 g or over

Note

The Animal Weighing Bowl Kit (GX-12) is available as an option for all models except GF-200.

The averaging time and stabilization range are set in “Condition ($Cond$)” and “Stability band width ($St-b$)”.

Averaging time			Stabilization range	
$Cond\ 0$	2 seconds	Faster	$St-b\ 0$	About $\pm 6\%$ of the weight value
$Cond\ 1$	4 seconds		$St-b\ 1$	About $\pm 12\%$ of the weight value
$Cond\ 2$	8 seconds	More accurate	$St-b\ 2$	About $\pm 25\%$ of the weight value

Zero tracking (t_{rc})

This function tracks zero point drift caused by changes in the environment and stabilizes the zero point. When the weighing data is only a few digits, turn the function off for accurate weighing.

Note

Digit, when used for the GF series balance, indicates a unit of minimum weighing value.

$t_{rc} 0$	The tracking function is not used. Used for weighing a very light sample.
$t_{rc} 1$	The tracking function is used. Normal zero tracking.
$t_{rc} 2$	The tracking function is used. Strong zero tracking.
$t_{rc} 3$	The tracking function is used. Very strong zero tracking.

Display refresh rate (SPd)

Period to refresh the display. This parameter influences “Baud rate”, “Data output pause” and “Stream mode”.

Note

This item is selected automatically in the manual response adjustment.

Decimal point (Pnt)

The decimal point format can be selected.

Auto display-ON ($P-on$)

When the AC adapter is connected, the display is automatically turned on without the ON:OFF key operation, to display the weighing mode. Used when the balance is built into an automated system. 30-minute warm up is necessary for accurate weighing.

Auto display-OFF ($P-off$)

When the AC adapter is connected and no operation is performed (inactivity state) for 10 minutes, the display is automatically turned off and the standby indicator is illuminated.

Capacity indicator (CSi)

In the weighing mode, the indicator displays the weighing data relative to the weighing capacity in percentage. (Zero = 0%, maximum capacity = 100%)

When the “Data memory ($dARR$)” parameter is set to “1” (to store unit mass in the counting mode) or to “2” (to store the weighing data), the indicator displays the information stored in memory, such as the amount of memory data or data number.

10-5 Description of the Item “Data output mode”

The parameter setting of the “Data output mode (*Pr t*)” applies to the performance when the “Data memory (*dRtR*)” parameter is set to “2” (to store the weighing data) and when the data is transmitted using the RS-232C interface.

Key mode

When the PRINT key is pressed with the stabilization indicator turned on, the balance outputs or stores the weighing data and the display blinks one time.

Required setting	<i>dout</i>	<i>Pr t</i> 0	Key mode
------------------	-------------	---------------	----------

Auto print modes A and B

When the displayed value is stable and the conditions of “Auto print polarity”, “Auto print difference” and reference value are met, the balance outputs or stores the weighing data.

When the PRINT key is pressed with the stabilization indicator turned on, the balance outputs or stores the data and the display blinks one time.

Mode A: Required setting	<i>dout</i>	<i>Pr t</i> 1	Auto print mode A (reference = zero)
	<i>dout</i>	<i>RP-P</i>	Auto print polarity
	<i>dout</i>	<i>RP-b</i>	Auto print difference

Example	“For weighing the added sample each time a sample is added, with “ <i>Rr-d</i> ” set to “1” (to adjust zero after the data is output).”
---------	---

Mode B: Required setting	<i>dout</i>	<i>Pr t</i> 2	Auto print mode B (reference = last stable value)
	<i>dout</i>	<i>RP-P</i>	Auto print polarity
	<i>dout</i>	<i>RP-b</i>	Auto print difference

Example	“For weighing while a sample is added.”
---------	---

Stream mode

The balance outputs the weighing data continuously regardless of the display condition. The display does not blink in this mode. This mode is not available and the interval memory mode is used when the “Data memory (*dRtR*)” parameter is set to “2” (to store the weighing data).

Required setting	<i>dout</i>	<i>Pr t</i> 3	Stream mode
	<i>dout</i>	<i>dRtR</i> 0	Data memory function is not used.
	<i>bRSFnc</i>	<i>SPd</i>	Display refresh rate
	<i>S iF</i>	<i>bPS</i>	Baud rate

Example	“For monitoring data on a computer”
---------	-------------------------------------

Caution

The balance may not transmit the data completely at the specified refresh rate, depending on the baud rate or data added to the weighing data such as time, date and ID number.

Interval memory mode

The weighing data is periodically stored in memory.

Required setting	<i>dout</i>	<i>Prt 3</i>	Interval memory mode
	<i>dout</i>	<i>dAtA 2</i>	Data memory function is used.
	<i>dout</i>	<i>int</i>	Stores weighing data.
			Interval time
Example	"For periodical weighing without a computer command and to output all of the data, to a computer, at one time"		

10-6 Description of the Item "Data format"

A&D standard format *SIF TYPE 0*

This format is used when the peripheral equipment can receive the A&D format. If an AD-8121B is used, set the printer to MODE 1 or 2.

- This format consists of fifteen characters excluding the terminator.
- A header of two characters indicates the balance condition.
- The polarity sign is placed before the data with the leading zeros. If the data is zero, the plus sign is used.
- The unit, consisting of three characters, follows the data.

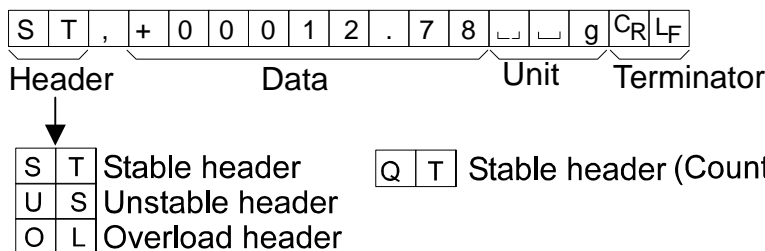

DP (Dump print) format *SIF TYPE 1*

This format is used when the peripheral equipment can not receive the A&D format. If an AD-8121B is used, set the printer to MODE 3.

- This format consists of sixteen characters excluding the terminator.
- A header of two characters indicates the balance condition. No overload header is used.
- The polarity sign is placed before the data, with spaces in place of leading zeros, if the data is not zero or overloaded.
- The unit, consisting of three characters, follows the data.

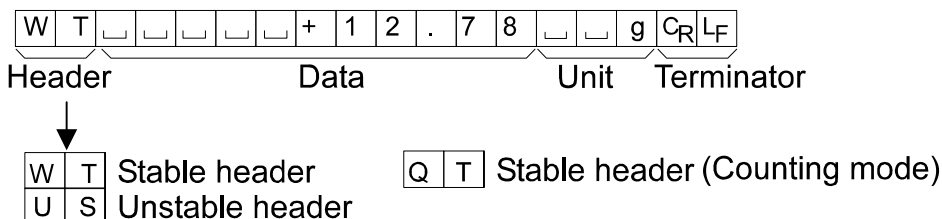

KF format *S, F TYPE 2*

This is the Karl-Fischer moisture meter format and is used when the peripheral equipment can only communicate using this format.

- This format consists of fourteen characters excluding the terminator.
- This format has no header characters.
- The polarity sign is placed before the data, with spaces in place of leading zeros, if the data is not zero or overloaded.
- This format outputs the unit only for a stable value.

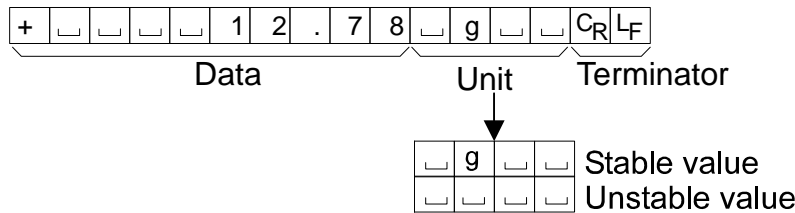

MT format *S, F TYPE 3*

- A header of two characters indicates the balance condition.
- The polarity sign is used only for negative data.
- The weighing data uses spaces in place of the leading zeros.
- The character length of this format changes dependent upon the unit

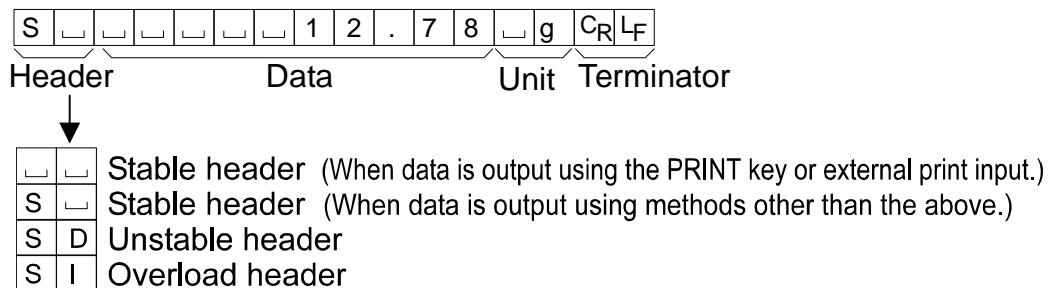

NU (numerical) format *S, F TYPE 4*

This format outputs only numerical data.

- This format consists of nine characters excluding the terminator.
- The polarity sign is placed before the data with the leading zeros. If the data is zero, the plus sign is used.

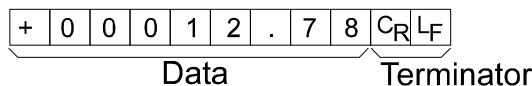

CSV format 5, F TYPE 5

- Separates the data of A&D standard format and the unit by a comma (,).
- Outputs the unit even when the data is overloaded.
- When the ID number and data number are added, outputs the ID number, data number and weighing data in this order and separates each item by a comma and treats all the items as one group of data.

LAB-123, No,012, ST,+00012.78, g<CR><LF>
ID number Data number Weighing data

S	T	,	+	0	0	0	1	2	.	7	8	,	<input type="text"/>	<input type="text"/>	g	C _R	L _F			
O	L	,	+	9	9	9	9	9	9	9	E	+	1	9	,	<input type="text"/>	<input type="text"/>	g	C _R	L _F

Note

To add the ID number and data number, the function settings must be changed.

10-7 Description of the Data Format Added to the Weighing Data

Data number *dout d-no l*

This format outputs the data number just before the data is transmitted using the RS-232C interface.

- This format consists of six characters excluding the terminator.
- When CSV format (5, F TYPE 5) is selected, the period (.) is replaced with a comma (,).

N	o	.	0	0	1	C _R	L _F
Data number						Terminator	

Note

The data number is added only to the weighing data that is stored in memory.

ID number *dout 5-id l*

The number to identify a specific balance.

- This format consists of seven characters excluding the terminator.

L	A	B	-	1	2	3	C _R	L _F
---	---	---	---	---	---	---	----------------	----------------

Note

When the data described above is added to the weighing data, the output is in the following order: ID number, Data number, and Weighing data.

10-8 Data Format Examples

Stable

° 127 9

A&D	S	T	,	+	0	0	0	0	1	.	2	7	␣	␣	g	C _R	L _F
DP	W	T	␣	␣	␣	␣	␣	␣	+	1	.	2	7	␣	␣	g	C _R L _F
KF	+	␣	␣	␣	␣	␣	1	.	2	7	␣	g	␣	␣	C _R	L _F	
MT*1	␣	␣	␣	␣	␣	␣	␣	␣	1	.	2	7	␣	g	C _R	L _F	
MT*2	S	␣	␣	␣	␣	␣	␣	␣	1	.	2	7	␣	g	C _R	L _F	
NU	+	0	0	0	0	1	.	2	7	C _R	L _F						

Note

Two formats are available for MT. *1 is the output format when the PRINT key or external print input is used. *2 is the output format for others.

Unstable

-18369 9

A&D	U	S	,	-	0	0	1	8	3	.	6	9	␣	␣	g	C _R	L _F
DP	U	S	␣	␣	␣	␣	-	1	8	3	.	6	9	␣	␣	g	C _R L _F
KF	-	␣	␣	␣	1	8	3	.	6	9	␣	␣	␣	␣	C _R	L _F	
MT	S	D	␣	␣	␣	-	1	8	3	.	6	9	␣	␣	C _R	L _F	
NU	-	0	0	1	8	3	.	6	9	C _R	L _F						

Overload

Positive error

Ⓔ 9

A&D	O	L	,	+	9	9	9	9	9	9	9	E	+	1	9	C _R	L _F
DP	␣	␣	␣	␣	␣	␣	␣	␣	E	␣	␣	␣	␣	␣	␣	C _R	L _F
KF	␣	␣	␣	␣	␣	␣	H	␣	␣	␣	␣	␣	␣	␣	␣	C _R	L _F
MT	S	I	+	C _R	L _F												
NU	+	9	9	9	9	9	9	9	9	C _R	L _F						

Overload

Negative error

-Ⓔ 9

A&D	O	L	,	-	9	9	9	9	9	9	9	E	+	1	9	C _R	L _F
DP	␣	␣	␣	␣	␣	␣	␣	-	E	␣	␣	␣	␣	␣	␣	C _R	L _F
KF	␣	␣	␣	␣	␣	␣	L	␣	␣	␣	␣	␣	␣	␣	␣	C _R	L _F
MT	S	I	-	C _R	L _F												
NU	-	9	9	9	9	9	9	9	9	C _R	L _F						

␣ Space, ASCII 20h

C_R Carriage Return, ASCII 0Dh

L_F Line Feed, ASCII 0Ah

Units		A&D	D.P	KF	MT
g	g	□□g	□□g	□g□□	□g
Counting mode	<i>PC</i>	□PC	□PC	□p c s	□P C S
Precent mode	<i>Pct</i>	□□%	□□%	□%□□	□%
Ounce (Avoir)	<i>oz</i>	□oz	□oz	□oz□	□oz
Pound	<i>Lb</i>	□lb	□lb	□lb□	□lb
Pound Ounce	<i>L oz</i>	□oz	□oz	□oz□	□oz
Troy Ounce	<i>ozt</i>	o z t	o z t	□o z t	□o z t
Metric Carat	<i>ct</i>	□c t	□c t	□c t□	□c t
Momme	<i>mm</i>	m o m	m o m	□m o m	□m o
Pennyweight	<i>dwt</i>	d w t	d w t	□d w t	□d w t
Grain	<i>GN</i>	□G N	□G N	□g r □	□G N
Tael (HK general, Singapore)	<i>TL</i>	□t l	□t l	□t l s	□t l
Tael (HK, jewelry)	<i>TL</i>	□t l	□t l	□t l h	□t l
Tael (Taiwan)	<i>TL</i>	□t l	□t l	□t l t	□t l
Tael (China)	<i>TL</i>	□t l	□t l	□t l c	□t l
Tola (India)	<i>t</i>	□□t	□□t	□t o l	□t
Messghal	<i>MS</i>	m e s	m e s	□M S□	□m
Density	<i>DS</i>	□D S	□D S	□D S□	□D S
Multi	(Blank)	□□□	□□□	□□□□	□

□ Space, ASCII 20h

Note

When “Pound Ounce” is selected, the data is output with the unit of ounce (oz).

10-9 Comparator Function

The results of the comparison are indicated by **HI** **OK** **LO** on the display.

Operating conditions:

- No comparison

- Comparison when the weighing data is stable or overloaded, excluding “near zero”
- Comparison when the weighing data is stable or overloaded, including “near zero”
- Continuous comparison, excluding “near zero”
- Continuous comparison, including “near zero”

To compare, use:

- Upper limit value and lower limit value
- Reference value and tolerance value

Input method:

- Digital input
- Weighing input
- Command input from a computer (Refer to “18. COMMANDS”).

Note

“Near zero” means within ± 10 digits of the minimum weighing value. For example, using a GF-2000 in gram mode, near zero is within ± 0.10 g.

For the description of “Comparator mode (CP Fnc)”, refer to “10-3 Details of the Function Table”.

Setting example 1

(Continuous comparison, excluding “near zero”, reference value and tolerance value, digital input)

Selecting a comparator mode

- 1 Press and hold the **SAMPLE** key until **BASEFnc** of the function table is displayed.
- 2 Press the **SAMPLE** key several times to display **CP Fnc**.
- 3 Press the **PRINT** key.
- 4 Press the **RE-ZERO** key several times to display **CP 3**.
- 5 Press the **SAMPLE** key several times to display **CP in**.
- 6 Press the **RE-ZERO** key several times to display **CP in 2**.
- 7 Press the **PRINT** key to store the selected mode.

Entering the reference and tolerance values

- 8 With **CP rEF** displayed, press the **PRINT** key. The current setting is displayed with all the digits blinking.
 - When the current setting is not to be changed, press the **PRINT** or **CAL** key to proceed to step 9.
 - When the current setting is to be changed, press the **RE-ZERO** key. Change the setting using the following keys.

SAMPLE key	To select the digit to change the value.
RE-ZERO key	To change the value of the digit selected.
MODE key	To switch the polarity.
PRINT key	To store the new setting and go to step 9.
CAL key	To cancel the new setting and go to step 9.

- 9 With $[P L n t]$ displayed, press the $[PRINT]$ key. The current setting is displayed. When the current setting is to be changed, change the setting using the following keys. Enter the tolerance value, in percentage to the reference value, as 100%.

$[SAMPLE]$ key To select the digit to change the value.

$[RE-ZERO]$ key To change the value of the digit selected.

$[PRINT]$ key To store the new setting and go to step 10.

$[CAL]$ key To cancel the new setting and go to step 10.

- 10 Press the $[CAL]$ key to exit the comparator function and return to the weighing mode.

Setting example 2

(Comparison when the weighing data is stable or overloaded, including “near zero”, upper limit and lower limit, weighing input)

Selecting a comparator mode

- 1 Press and hold the $[SAMPLE]$ key until $bRSFnC$ of the function table is displayed.
- 2 Press the $[SAMPLE]$ key several times to display $[P F n C]$.
- 3 Press the $[PRINT]$ key.
- 4 Press the $[RE-ZERO]$ key several times to display $[P 2]$.
- 5 Press the $[SAMPLE]$ key several times to display $[P in]$.
- 6 Press the $[RE-ZERO]$ key several times to display $[P in 1]$.
- 7 Press the $[PRINT]$ key to store the selected mode.

Entering the upper and lower limit values

- 8 With $[P H i]$ displayed, press the $[PRINT]$ key. The current setting is displayed with all of the digits blinking. Press the $[RE-ZERO]$ key to enter the weighing input mode.
- 9 Press the $[RE-ZERO]$ key. The balance displays $0.00g$. Place a sample with a mass that corresponds to the upper limit value on the pan. Press the $[PRINT]$ key to store the upper limit value. Remove the sample. The balance displays $[P L 0]$.
- 10 With $[P L 0]$ displayed, press the $[PRINT]$ key. The current setting is displayed with all of the digits blinking. Press the $[RE-ZERO]$ key to enter the weighing input mode.
- 11 Press the $[RE-ZERO]$ key. The balance displays $0.00g$. Place a sample with a mass that corresponds to the lower limit value on the pan. Press the $[PRINT]$ key to store the lower limit value. Remove the sample.
- 12 Press the $[CAL]$ key to exit the comparator function and return to the weighing mode.

Notes

- When Pound/Ounce is selected as a weighing unit, enter the values in ounces for comparison.
- In the density mode, comparison is performed to the density obtained.

11. ID NUMBER AND GLP REPORT

- The ID number is used to identify the balance when Good Laboratory Practice (GLP) is used.
- The ID number is maintained in non-volatile memory even if the AC adapter is removed.
- The GLP output format is selected at “GLP output (*INF0*)” of the function table and can be output to a personal computer or printer using the RS-232C serial interface.
- The GLP output format includes the balance manufacturer, model, serial number, ID number and space for signature for weighing data, and the weight used and results for calibration or calibration test data.

When the AD-8121B is used, the date and time can be printed using the AD-8121B clock and calendar function. In this case, set the “GLP output (*INF0*)” parameter to “1”.

- The balance can output the following reports for GLP.
 - “Calibration report” of the calibration, using an external weight.
 - “Calibration test report” of the calibration test, using an external weight.
 - “Title block” and “End block” for the weighing data.

11-1 Setting the ID Number

- 1 Press and hold the **SAMPLE** key until **bRSFnC** of the function table is displayed.
- 2 Press the **SAMPLE** key several times to display **id**.
- 3 Press the **PRINT** key. Set the ID number using the following keys.
 - RE-ZERO** key To set the character of the digit selected. Refer to the display character set shown below.
 - SAMPLE** key To select the digit to change the value.
 - PRINT** key To store the new ID number and display **bRSFnC**.
 - CAL** key To cancel the new ID number and display **bRSFnC**.
- 4 With **bRSFnC** displayed, press the **CAL** key to return to the weighing mode.

Display character set

0	1	2	3	4	5	6	7	8	9	-	_	A	B	C	D	E	F	G	H	I	J	K	L	M	N	O	P	Q	R	S	T	U	V	W	X	Y	Z
0	1	2	3	4	5	6	7	8	9	-	_	A	b	c	d	e	f	g	h	i	j	k	l	m	n	o	p	q	r	s	t	u	v	w	x	y	z

_ Space

11-2 GLP Report

Set the following parameters to output the report.

- To print the report, set the “GLP output (*INF0*)” parameter to “1” and use MODE 3 of the AD-8121B. For details on using the printer, refer to “17-1 Connection to the AD-8121B Printer”. If the time and date are not correct, adjust the AD-8121B clock and calendar.
- To output the report to a personal computer using the RS-232C interface, set the “GLP output (*INF0*)” parameter to “2”.

Note

For operational details about calibration and calibration test, refer to “8. CALIBRATION”.

Calibration report using an external weight

When the setting is “*info 1*”:

AD-8121 format

```

      A & D
MODEL   GF-2000
S/N     01234567
ID      ABCDEFG
DATE    2008/04/18
TIME    11:12:09
CALIBRATED(EXT.)
CAL.WEIGHT
      +2000.00 g
SIGNATURE
-----
    
```

← Manufacturer →
 ← Model →
 ← Serial number →
 ← ID number →
 ← Date →
 ← Time →
 ← Calibration type →
 ← Calibration weight →
 ← Signature →

When the setting is “*info 2*”:

General data format

```

..... A_&_D<TERM>
MODEL.....GF-2000<TERM>
S/N.....01234567<TERM>
ID.....ABCDEFG<TERM>
DATE<TERM>
<TERM>
TIME<TERM>
<TERM>
CALIBRATED(EXT.)<TERM>
CAL.WEIGHT<TERM>
.....+2000.00_g<TERM>
SIGNATURE<TERM>
<TERM>
<TERM>
-----<TERM>
<TERM>
<TERM>
    
```

□ Space, ASCII 20h

<TERM> Terminator, C_R, L_F or C_R

C_R Carriage return, ASCII 0Dh

L_F Line feed, ASCII 0Ah

Calibration test report using an external weight

(Calibration test does not perform calibration.)

When the setting is “*info 1*”:

AD-8121 format

```

      A & D
MODEL   GF-2000
S/N     01234567
ID      ABCDEFG2020
DATE    2008/04/18
TIME    11:12:09
CAL.TEST(EXT.)
ACTUAL
      0.00 g
      +1999.99 g
TARGET
      +2000.00 g
SIGNATURE
-----
    
```

← Manufacturer →
 ← Model →
 ← Serial number →
 ← ID number →
 ← Date →
 ← Time →
 ← Calibration test type →
 ← Zero point value →
 ← Target weight value →
 ← Target weight →
 ← Signature →

When the setting is “*info 2*”:

General data format

```

..... A_&_D<TERM>
MODEL.....GF-2000<TERM>
S/N.....01234567<TERM>
ID.....ABCDEFG<TERM>
DATE<TERM>
<TERM>
TIME<TERM>
<TERM>
CAL. TEST (EXT.)<TERM>
ACTUAL<TERM>
.....0.00_g<TERM>
.....+1999.99_g<TERM>
TARGET<TERM>
.....+2000.00_g<TERM>
SIGNATURE<TERM>
<TERM>
<TERM>
-----<TERM>
<TERM>
<TERM>
    
```

□ Space, ASCII 20h

<TERM> Terminator, C_R, L_F or C_R

C_R Carriage return, ASCII 0Dh

L_F Line feed, ASCII 0Ah

Title block and end block

When a weight value is recorded as the GLP data, “Title block” and “End block” are inserted at the beginning and at the end of a group of weight values, in the GLP report.

Note

To output the report to an AD-8121B , use MODE 3 of the AD-8121B.

Caution

If the data memory function is used, the “Title block” and “End block” can not be output.

Operation

- 1 With the weighing data displayed, press and hold the **PRINT** key until **Start** is displayed. The “Title block” is output.
- 2 The weighing data is output according to the parameter setting of the data output mode.
- 3 Press and hold the **PRINT** key until **RecEnd** is displayed. The “End block” is output.

When the setting is “inF0 1”:

When the setting is “inF0 2”:

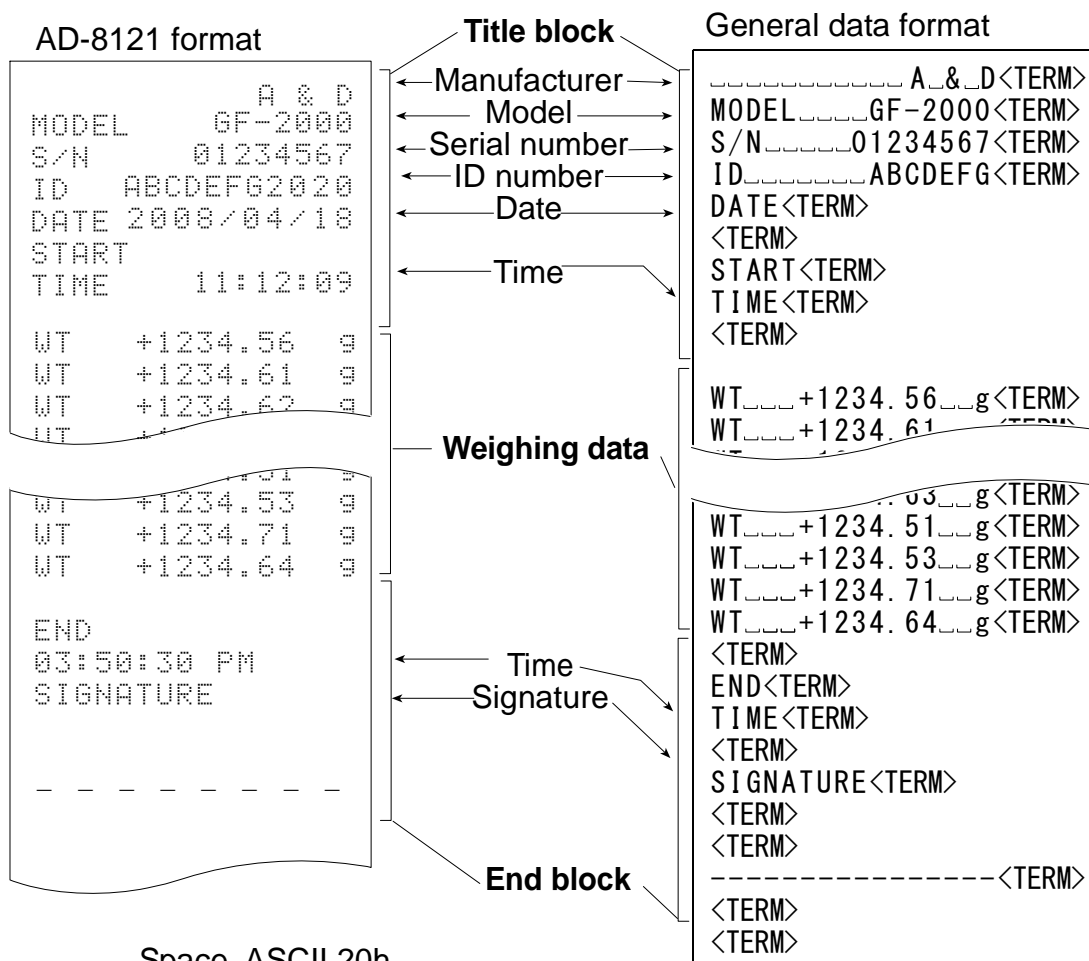

- Space, ASCII 20h
- <TERM> Terminator, C_R, L_F or C_R
- C_R Carriage return, ASCII 0Dh
- L_F Line feed, ASCII 0Ah

12. DATA MEMORY

Data memory is a function to store weighing data and unit mass in memory. Of the data in memory, the balance can only display the weighing data. The weighing data in memory is available for outputting at one time to a printer or personal computer.

One of the following data set can be stored:

- Weighing data (Up to 40 sets.)
- Unit mass in the counting mode (Up to 20 sets)

12-1 Notes on Using Data Memory

To use the memory function, set the "Data memory (*DATA*)" parameter of the function table. For details on setting the data memory, refer to "10. FUNCTION TABLE".

Releasing "[Lr]"

If a different type of data exists in memory when the data is stored, "[Lr]" appears blinking in the upper left of the display. For example, you want to store weighing data but unit mass data remains in memory.



Under such a condition, before storing data, delete the data in memory as follows:

- 1 Press and hold the **PRINT** key until **[Lr no]** with "no" blinking is displayed.
- 2 Press the **RE-ZERO** key to display **[Lr Go]** with "Go" blinking.

The type of data stored in memory appears on the upper left of the display as shown below:

Unit mass in the counting mode	PE
Weighing data without time and date	-d-

- 3 Press the **PRINT** key to delete all the data in memory.
- 4 The balance displays **[End]** and returns to the weighing mode.

12-2 Memory for Weighing Data

- The data memory function can store 40 sets of weighing data. Even if the AC adapter is removed, the data is maintained in non-volatile memory.
- It is not necessary that the printer or computer be continually connected to the balance, because the balance stores the weighing data in memory.
- The data in memory is available to be displayed on the balance for confirmation, or to output several sets of data at one time to a printer or personal computer. In the function setting, what data is to be added to the output data (ID number and data number) can be selected.

Storing the weighing data

Note

If “*Lr*” appears blinking in the upper left of the display, delete the data in memory.

- 1 Set the “Data memory (*dAtA*)” parameter to “2”.
- 2 The storing operation depends on the “Data output mode (*Prt*)” parameter setting. Four types of operating modes are available to store data.

Key mode	When the PRINT key is pressed and the displayed value is stable, the balance stores the weighing data.
Auto print modes A and B	When the displayed value is stable and the conditions of “Auto print polarity”, “Auto print difference” and reference value are met, the balance stores the weighing data.
Interval memory mode	Weighing data is stored at an interval specified in “Interval time (<i>int</i>)”. Press the PRINT key to start and stop this mode.

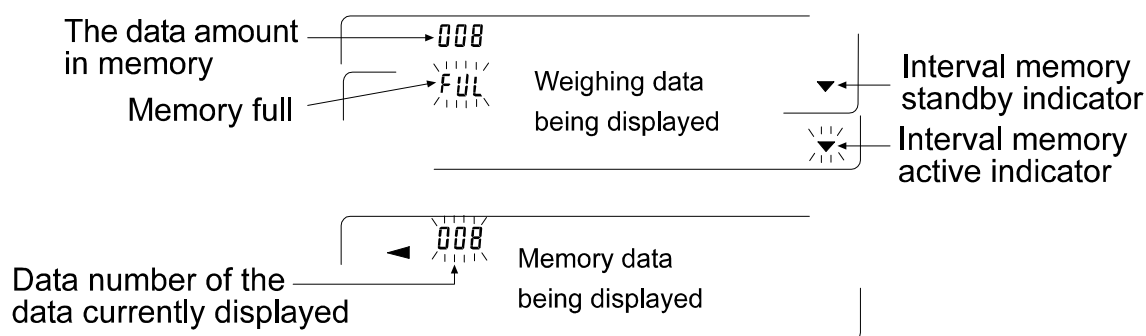

Caution

- When weighing data is being stored in memory, the data can not be output to a personal computer using the RS-232C interface.
- “FUL” indicates that memory is full or the memory capacity has been reached. More data can not be stored unless the memory data is deleted.

- The following commands can not be used during data storage.

Q Query command for weighing data.

S, $E_{SC}P$ Query command for stable weighing data.

SI Query command for weighing data.

SIR Query command for continuous weighing data.

E_{SC} : 1Bh in ASCII code

Setting the function table

Parameter settings for each output mode are as follows:

Item	Data output mode	Auto print polarity, difference	Data memory function	Interval time
Key mode	<i>Prt 0</i>	Not used	<i>dAtA 2</i>	Not used
Auto print mode A	<i>Prt 1</i>	<i>AP-A 0-2</i>	<i>dAtA 2</i>	
Auto print mode B	<i>Prt 2</i>	<i>AP-b 0-2</i>	<i>dAtA 2</i>	
Interval memory mode	<i>Prt 3</i>	Not used	<i>dAtA 2</i>	<i>int 0-8</i>

Set each item, depending on the situation, as follows:

Data number	No	<i>d-no 0</i>
	Yes	<i>d-no 1</i>
ID number	No	<i>S-id 0</i>
	Yes	<i>S-id 1</i>

Enabling the data memory function

- 1 Press and hold the **SAMPLE** key until **bRSFnc** of the function table is displayed.
- 2 Press the **SAMPLE** key several times to display **dout**.
- 3 Press the **PRINT** key.
- 4 Press the **SAMPLE** key three times to display **dAtA 0**.
- 5 Press the **RE-ZERO** key to change **dAtA 0** to **dAtA 2**.
- 6 Press the **PRINT** key to save.
- 7 Press the **CAL** key to return to the weighing mode.

Recalling the memory data

Confirm that the “Data memory (*dAtA*)” parameter is set to “2”.

- 1 Press and hold the **PRINT** key until **rECALL** is displayed.
- 2 Press the **PRINT** key to enter the memory recall mode. Recall the data in memory using the following keys

RE-ZERO key	To proceed to the next data set.
MODE key	To go back to the previous data set.
PRINT key	To transmit the current data using the RS-232C interface.

With **SAMPLE** held down, press the **CAL** key
To delete the data currently displayed.

Note: Deleting the data will not increase the number of data that can be stored.

CAL key To exit the memory recall mode.

- 3 Press the **CAL** key to return to the weighing mode.

Transmitting all memory data at one time

Confirm that the “Serial interface (*SIF*)” parameters are set properly. For details, refer to “10. FUNCTION TABLE” and “17. CONNECTION TO PERIPHERAL EQUIPMENT”.

- 1 Press and hold the **PRINT** key until **rECALL** is displayed.
- 2 Press the **SAMPLE** key to display **out**.
- 3 Press the **PRINT** key to display **out no** with “no” blinking.
- 5 Press the **RE-ZERO** key to display **out Go** with “Go” blinking.
- 6 Press the **PRINT** key to transmit all data using the RS-232C interface.
- 7 The balance displays **CLEAR** when all data is transmitted. Press the **CAL** key to return to the weighing mode.

Deleting all memory data at one time

- 1 Press and hold the **PRINT** key until **rECALL** is displayed.
- 2 Press the **SAMPLE** key several times to display **CLEAR**.
- 3 Press the **PRINT** key to display **Clr no** with “no” blinking.
- 4 Press the **RE-ZERO** key to display **Clr Go** with “Go” blinking.
- 5 Press the **PRINT** key to delete all data
- 6 The balance displays **End**, then **rECALL** when all data is deleted.
- 7 Press the **CAL** key to return to the weighing mode.

12-3 Memory for Unit Mass in the Counting Mode

- The data memory function can store 20 sets of unit mass for the counting mode. Even if the AC adapter is removed, the data is maintained in non-volatile memory. Among the 20 sets, “P01” is the memory function for the standard counting mode.
- The unit mass in memory can be recalled and used for weighing.
- The unit mass in memory can be recalled and changed.

Recalling the unit mass

- 1 Set the “Data memory (dATA)” parameter to “1”.
- 2 Press the **MODE** key to select **PC** (counting mode).

Notes

- If the counting mode can not be selected, refer to “5. WEIGHING UNITS”.
- If “Lr” appears blinking in the upper left of the display, delete the data in memory.

- 3 Press and hold the **PRINT** key until the balance enters the sample unit mass selection mode as shown below.

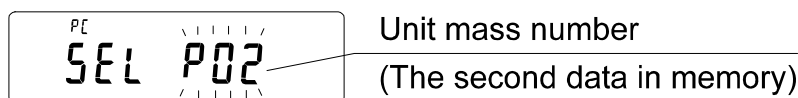

- 4 Select the unit mass to be used using the following keys.

RE-ZERO key	To increase the unit mass number by one.
MODE key	To decrease the unit mass number by one.
PRINT key	To select the unit mass number to be used.
CAL key	To cancel the operation and go to step 5.

- 5 To re-store the unit mass or perform Automatic Counting Accuracy Improvement (ACAI) on the stored unit mass, follow the procedure described in “6-2 Counting Mode (PC)”.

Notes

- ACAI can not be performed on the recalled unit mass.
- Using the “UN:mm” command, the unit mass stored in memory can be recalled. (“mm” will be replaced by a two-digit number, 01 to 20, that corresponds to the unit mass numbers, P01 to P20.) The recalled unit mass can be output by the “?UW” command and can be changed by the “UW: ” command.

13. UNDERHOOK

The underhook can be used for weighing large samples, magnetic materials or for measuring density. The built-in underhook is revealed by removing the plastic cap on the bottom of the balance. Use the underhook as shown below.

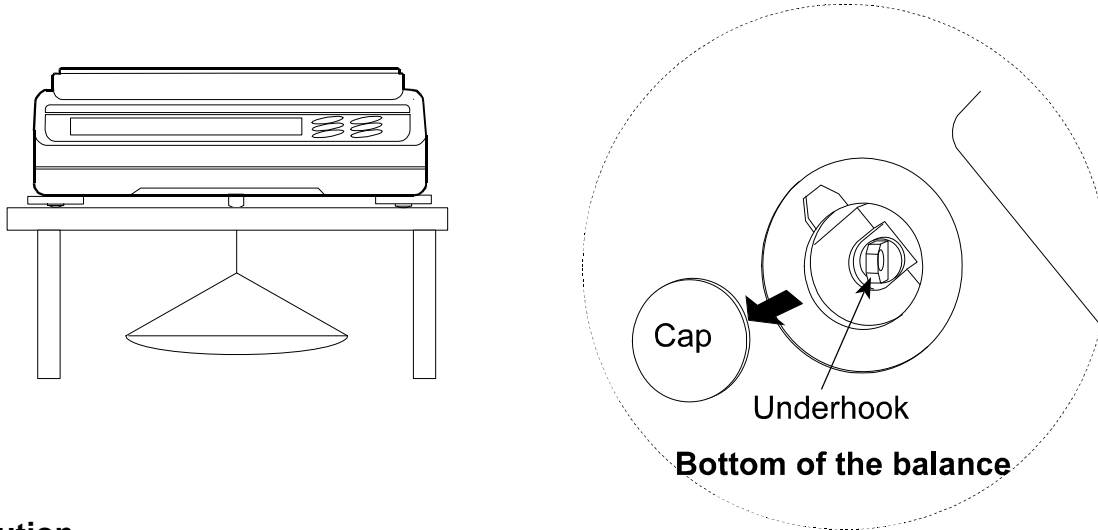

Caution

Do not apply excessive force to the underhook.

When not in use, attach the plastic cap to prevent dust from getting into the balance.

14. PROGRAMMABLE-UNIT

This is a programmable unit conversion function. It multiplies the weighing data in grams by an arbitrary coefficient set in the function table and displays the result.

The coefficient must be within the range between the minimum and maximum shown below. If the coefficient set is beyond the range, an error is displayed and the balance returns to the coefficient setting mode, prompting to enter an appropriate value. A coefficient of 1 was set at the factory.

Model	Minimum coefficient	Maximum coefficient
GF-200/300/400/600/800/1000	0.000001	1000
GF-1200/2000/3000/4000/6100		100
GF-6000/8000		10

Operation

- 1 Press and hold the **SAMPLE** key until **0.95Fnc** of the function table is displayed.
- 2 Press the **SAMPLE** key several times to display **1.000000**.
- 3 Press the **PRINT** key. The balance enters the mode to confirm or set the coefficient.

Confirming the coefficient

- 4 The current coefficient is displayed with the first digit blinking.
 - When it is not to be changed, press the **CAL** key and proceed to step 6.
 - When it is to be changed, press the **RE-ZERO** key and proceed to step 5.

Setting the coefficient

- 5 Set the coefficient using the following keys.

SAMPLE key To select a digit to change the value. The selected digit blinks.

RE-ZERO key To change the value.

MODE key To change the decimal point position.

Each time the switch is pressed, the decimal point position changes as follows:

→ 0.000001 → 00.00001 → ... → 000000.1 → 0000001 →

PRINT key To store the new setting, display **End** and go to step 6.

CAL key To cancel the new setting and go to step 6.

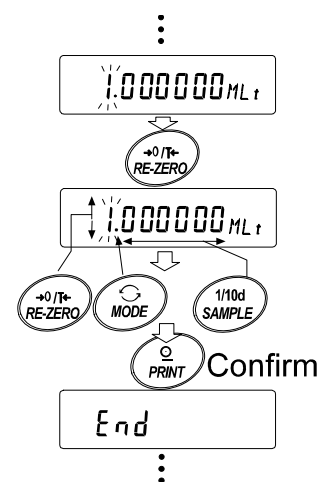

Quitting the operation

- 6 The balance displays **Unit**. Press the **CAL** key to exit the programmable-unit function and return to the weighing mode.

Using the function

Press the **MODE** key to select the programmable-unit (no display on the unit section). Perform weighing as described in "6-1 Basic Operation (Gram Mode)". After weighing, the balance displays the result (weighing data in grams x coefficient).

15. DENSITY MEASUREMENT

The GF series balance is equipped with a density mode. It calculates the density of a solid using the weight of a sample in air and the weight in liquid.

- The density mode was not selected for use when the balance was shipped from the factory. To use the mode, change the function table and activate the density mode.
- Two ways to set the density of a liquid are available:
by entering the water temperature or by entering the density directly.
- The density determination kit (GX-13) is available as an option for GF-200/300/400/600/800/1000.

Formula to obtain the density

The density can be obtained by the following formula.

$$\rho = \frac{A}{A - B} \times \rho_0$$

Where ρ : Density of a sample
 A: Weight value of a sample in air
 B: Weight value of a sample in liquid
 ρ_0 : Density of a liquid

Changing the function table

(1) Selecting the density mode

The density mode is available as one of the weighing units. To use the mode, select it in the function table. For details, refer to "5-2 Storing Units".

(2) Selecting a way to set the density of a liquid

Select the liquid density input method from the function table below. The function table is available only when the density mode is selected.

Class	Item	Parameter	Description
d5 Fnc	Ld in	$\bar{\square}$	Water temperature
Density function	Liquid density input	l	Liquid density

$\bar{\square}$ = Factory setting

Setting the density of a liquid

1. Press the **MODE** key as necessary to select the density mode. When the processing indicator blinks with the unit "g" displayed, it indicates that the density mode is selected.
2. In the density mode, press and hold the **MODE** key to enter the mode to set the liquid density.

Note

In the normal weighing mode, the same procedure will activate the manual response adjustment/self check function. These are not available in the density mode.

Entering the water temperature (Ld in $\bar{\square}$)

In the density mode, press and hold the **MODE** key until the water temperature currently set (unit:°C, factory setting : 25°C) is displayed. Use the following keys to change the value.

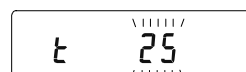

- | | |
|--------------------|---|
| RE-ZERO key | To increase the temperature by one degree. (0-99) |
| MODE key | To decrease the temperature by one degree. (0-99) |
| PRINT key | To store the change, display End and return to the density mode. |
| CAL key | To cancel the change and return to the density mode. |

The relation between the water temperature and density is shown below.

Temp. (°C)	+0	+1	+2	+3	+4	+5	+6	+7	+8	+9
0	0.99984	0.99990	0.99994	0.99996	0.99997	0.99996	0.99994	0.99990	0.99985	0.99978
10	0.99970	0.99961	0.99949	0.99938	0.99924	0.99910	0.99894	0.99877	0.99860	0.99841
20	0.99820	0.99799	0.99777	0.99754	0.99730	0.99704	0.99678	0.99651	0.99623	0.99594
30	0.99565	0.99534	0.99503	0.99470	0.99437	0.99403	0.99368	0.99333	0.99297	0.99259
40	0.99222	0.99183	0.99144	0.99104	0.99063	0.99021	0.98979	0.98936	0.98893	0.98849
50	0.98804	0.98758	0.98712	0.98665	0.98618	0.98570	0.98521	0.98471	0.98422	0.98371
60	0.98320	0.98268	0.98216	0.98163	0.98110	0.98055	0.98001	0.97946	0.97890	0.97834
70	0.97777	0.97720	0.97662	0.97603	0.97544	0.97485	0.97425	0.97364	0.97303	0.97242
80	0.97180	0.97117	0.97054	0.96991	0.96927	0.96862	0.96797	0.96731	0.96665	0.96600
90	0.96532	0.96465	0.96397	0.96328	0.96259	0.96190	0.96120	0.96050	0.95979	0.95906

Entering the density directly (*L d in l*)

In the density mode, press and hold the **MODE** key until the density currently set (unit : g / cm³, factory setting : 1.000g / cm³) is displayed. Use the following keys to change the value.



- RE-ZERO** key To set the value of the digit selected.
- SAMPLE** key To select the digit to change the value.
- PRINT** key To store the change, display **End** and return to the density mode.
- CAL** key To cancel the change and return to the density mode.

Note

The range to set the density is 0.0000 to 1.9999 g / cm³

Measuring the density

In the density measurement, the balance displays the weight of a sample in air, the weight in liquid and then the density.

- Measuring the weight of a sample in air.

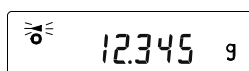

The processing indicator blinks with the unit "g" displayed.

- Measuring the weight of a sample in liquid.

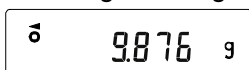

The processing indicator illuminates with the unit "g" displayed.

- Displaying the density.

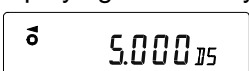

The processing indicator illuminates with "DS" displayed.

To cycle through the above three, press the **SAMPLE** key.

Note

The **SAMPLE** key can not be used to change the minimum weighing value. The density is displayed with three decimal places.

Measuring procedure

- 1 Confirm that the balance is in the mode to measure the weight of the sample in air. ("g" displayed and processing indicator blinking)
- 2 Confirm that the balance indicates zero. If it does not indicate zero, press the **RE-ZERO** to reset the displayed value to zero.
- 3 Place the sample on the upper pan (in air). When the value displayed on the balance becomes stable, press the **SAMPLE** key to confirm the value (the weight of the sample in air). The balance enters the mode to measure the weight of the sample in liquid ("g" displayed and processing indicator illuminating).

Note

If a negative value or E (error) is displayed, the **SAMPLE** key is disabled.

- 4 Remove the sample from the upper pan and place it on the lower pan (in liquid). When the value displayed on the balance becomes stable, press the **SAMPLE** key to confirm the value (the weight of the sample in liquid). The balance enters the mode to display the density ("g" disappears).

Note

If E (error) is displayed, the **SAMPLE** key is disabled.

- 5 To output or store the density, press the **PRINT** key. The density output unit is "DS". To measure the density of another sample, press the **SAMPLE** key to return to the mode to measure the weight in air and repeat the procedure described above.

Note

If the liquid temperature or the type of liquid is changed during measurement, reset the value of the liquid density as necessary. For details, refer to "Setting the density of a liquid".

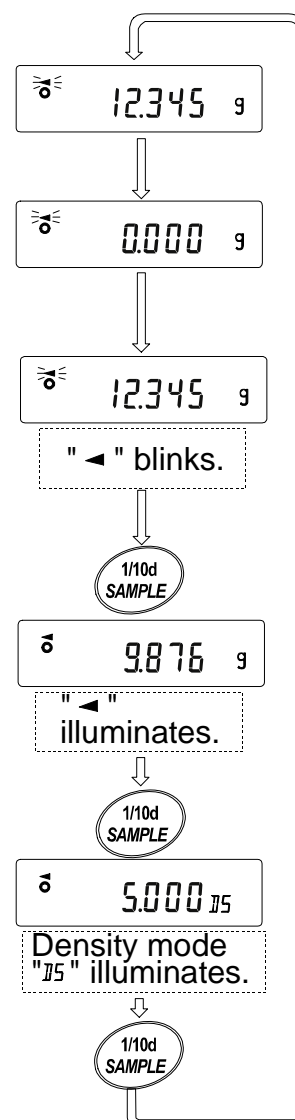

16. RS-232C SERIAL INTERFACE / EXTERNAL INPUT

Transmission system : EIA RS-232C
 Transmission form : Asynchronous, bi-directional, half duplex
 Data format : Baud rate : 600, 1200, 2400, 4800, 9600 bps
 Data bits : 7 or 8 bits
 Parity : Even, Odd (Data bits 7 bits)
 None (Data bits 8 bits)
 Stop bit : 1 bit
 Code : ASCII

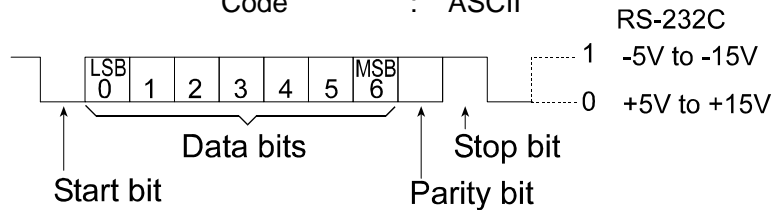

Pin connections

Pin No.	Signal name	Direction	Description
1	FG	-	Frame ground
2	RXD	Input	Receive data
3	TXD	Output	Transmit data
4	RTS	Input	Ready to send
5	CTS	Output	Clear to send
6	DSR	Output	Data set ready
7	SG	-	Signal ground
18	PRINT	Input	Same as the PRINT key
19	RE-ZERO	Input	Same as the RE-ZERO key
8 – 25 (Excluding 18 and 19)	-	-	Not connected

Circuits

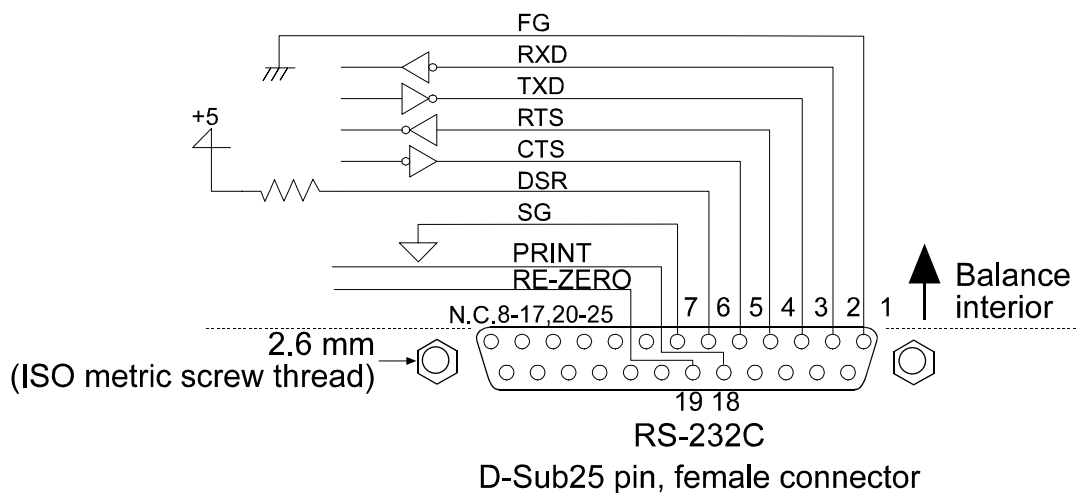

External input

Pin 18 and pin 19 perform the same function as pressing the **PRINT** and **RE-ZERO** keys respectively by connecting each pin to pin 7 for at least 100 ms.

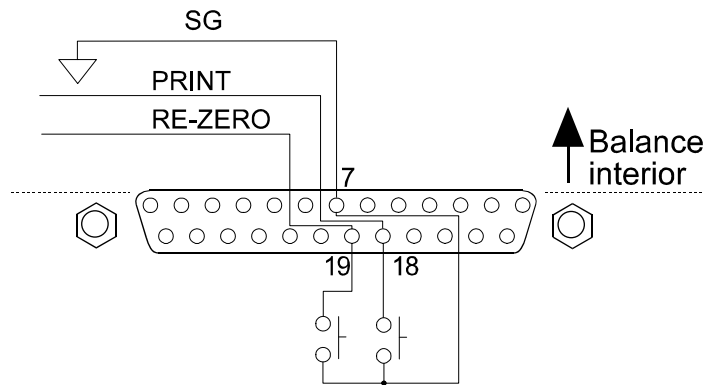

Use of example

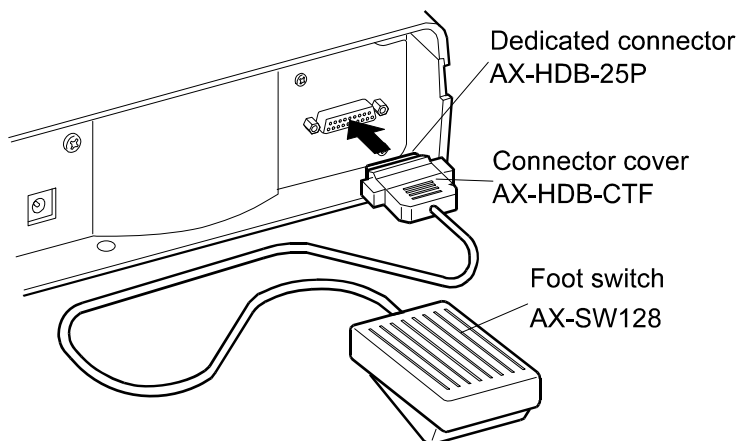

The external input connector (AX-HDB-25P/CTF) and the foot switch (AX-SW128) are sold separately.

17. CONNECTION TO PERIPHERAL EQUIPMENT

17-1 Connection to the AD-8121B Printer

Set the following parameters to use the AD-8121B printer.

Function setting	Description
<i>dout Prt</i> 0-3	Selects a print mode.
<i>dout RP-P</i> 0-2	Selects the polarity for the auto print mode.
<i>dout RP-b</i> 0-2	Selects the auto print difference.
<i>dout PUSE</i> 0,1	Selects data output pause.
<i>S iF bPS</i> 2 Factory setting	2400 bps
<i>S iF bPr</i> 0 Factory setting	7 bits, Even parity check
<i>S iF CrLF</i> 0 Factory setting	CR, LF
<i>S iF Cts</i> 0 Factory setting	CTS and RTS control, not used

When "MODE 1" or "MODE 2" of the AD-8121B printer is used	
<i>dout S-id</i> 0 Factory setting	Does not output the ID number.
<i>dout Rt-F</i> 0 Factory setting	Does not perform auto feed.
<i>S iF tYPE</i> 0 Factory setting	A&D standard format

When "MODE 3" of the AD-8121B printer is used.	
<i>dout S-id</i> 0, 1	Select whether or not the ID number is output.
<i>dout Rt-F</i> 0, 1	Select whether or not auto feed is performed.
<i>S iF tYPE</i> 1	DP format

When data is transmitted continuously./When all memory data is transmitted at one time.	
<i>dout PUSE</i> 1	Uses pause.

Note

The printer performs as follows, depending on the data memory setting.

Setting	What is printed
<i>dRtR</i> 0	The weighing data
<i>dRtR</i> 2	The weighing data stored in memory

Refer to "11. ID NUMBER AND GLP REPORT" for a print sample.

17-2 Connection to a Computer

The GF series balance is of the DCE type (Data Communication Equipment), which can be connected to a personal computer using the RS-232C interface.

Before connection, read the personal computer manual thoroughly.

Use a standard DCE cable for connection (cable type: straight-through).

17-3 Using Windows Communication Tools (WinCT)

When Windows is used as an operating system in a personal computer, the WinCT software can be used to transmit the weighing data to the personal computer.

The WinCT has two communication methods: "RsCom" and "RsKey". For details on WinCT, refer to the WinCT instruction manual.

The current version of the WinCT can be downloaded from the A&D website.

RsCom

- Can transmit commands to control the balance.
- Can make bi-directional communication between the balance and a personal computer using the RS-232C interface.
- Can display or store the data using a text file format. Can also print the data using a printer connected to the personal computer.
- When several ports of a personal computer have balances connected, the personal computer can communicate with each balance simultaneously.
- Can share a personal computer with other application software.
- Can receive the balance GLP report.

RsKey

- Can transmit the weighing data output from the balance directly to other application software such as Microsoft Excel.
- Can be used with most application software.
- Can receive the balance GLP report.

Note

Windows and Excel are the registered trademarks of the Microsoft Corporation.

Using the WinCT software, the balance can do the following:

- 1 Analyzing the weighing data and the statistics input by "RsKey"
The weighing data can be input directly into an Excel worksheet. Then, Excel can analyze the data to obtain total, average, standard deviation, maximum and minimum value, and display them in a graph.
- 2 Controlling the balance using commands from a personal computer
By using "RsCom", the personal computer sends commands such as "re-zero" or "send weighing data" to the balance and controls the balance.
- 3 Printing the balance GLP report using your printer
The balance GLP report can be printed using a printer connected to the personal computer.
- 4 Receiving weighing data at a certain interval
The weighing data can be received at a certain interval and data characteristic with elapsed time can be obtained.

5 Using the GF series balance memory function

The weighing data, instead of outputting it immediately to an external device, can be stored in the balance's memory. Later, all of the weighing data stored can be output to a personal computer at one time.

6 Using a personal computer as an external indicator

With the "RsKey" test mode function, a personal computer can be used as an external weight indicator for the balance. (To do this, set the balance data output mode to stream mode.)

18. COMMANDS

18-1 Command List

Commands to query weighing data

C	Cancels the S or SIR command.
Q	Requests the weighing data immediately.
S	Requests the weighing data when stabilized.
SI	Requests the weighing data immediately.
SIR	Requests the weighing data continuously.
^E_{sc}P	Requests the weighing data when stabilized.

Note: The “Q” and “SI” commands, the “S” and “^E_{sc}P” commands behave the same.

Commands to control the balance

CAL	Same as the CAL key.
MCL	Deletes all data in memory.
MD:nnn	Deletes weighing data with the data number nnn.
OFF	Turns the display off.
ON	Turns the display on.
P	Same as the ON:OFF key
PT:***. ** \square g	Sets the tare value. The unit added is the unit that is output in the A&D standard format. For the counting or percent mode, gram is used. Set the tare value so that the total value of the sample and the tare does not exceed the weighing capacity. Negative values can not be used.
?PT	Requests the tare value. Outputs the tare value set by the TR or PT: command.
R	Same as the RE-ZERO key
SMP	Same as the SAMPLE key.
U	Same as the MODE key
T	Same as the RE-ZERO key
TR	Tares the balance (Cancels the container’s weight.) Available only when the load on the weighing pan is greater than the zero point. The zero point is set by the R, T or Z command, by pressing the RE-ZERO key, or using the external input.
Z	Same as the RE-ZERO key
^E_{sc}T	Same as the RE-ZERO key

Note: The “R”, “T”, “Z” and “^E_{sc}T” commands behave the same.

Commands to control the memory function

?MA	Outputs all data in memory.
?MQnnn	Outputs weighing data with the data number nnn.
?MX	Outputs the number of weighing data in memory.
MCL	Deletes all data in memory.
MD:nnn	Deletes weighing data with the data number nnn.
UN:mm	Changes the unit mass stored in memory with the number of mm (01-20).
?UN	Outputs the unit mass number of the selected unit mass.
UW:***. ** \square g	Sets the unit mass value. e.g., UW:+0.123 \square g (to set the unit mass to 0.123 g: \square represents a space.)
?UW	Outputs the unit mass value of the selected unit mass number.
?ID	Requests the ID number.
?SN	Requests the serial number.
?TN	Requests the model name.

Commands to control the comparator function

HI:***. **_ _g	Sets the upper limit value. e.g.,HI:+2.34_ _g (to set the upper limit value to 2.34 g; _ represents a space.)
LO:***. **_ _g	Sets the lower limit value. e.g.,LO:+1.23_ _g (to set the lower limit value to 1.23 g; _ represents a space.)
?HI	Outputs the upper limit value.
?LO	Outputs the lower limit value.

Notes

- “nnn” and “mm” indicate, respectively, three-digit and two-digit numerical values.
E_{SC}: 1Bh in ASCII code
- Before transmitting a command, add the terminator (<CR><LF> or <CR>), that is specified in the “Terminator (E_{rLF})” parameter of “Serial interface (S_{iF})” in the function table, to the command.
- To use a command to control the comparator function, set the “Input method (E_{PM})” parameter to “0” or “1”.

18-2 Acknowledge Code and Error Codes

When the “Serial interface function (S_{iF})” parameter is set to “E_{rEd} 1”, the balance outputs <AK> code or an error code for each command as follows:

<AK> (06h) Acknowledge in ASCII code.

- When the balance receives a command to request data and can not process it, the balance transmits an error code (EC, Exx).
When the balance receives a command to request data and can process it, the balance outputs the data.
- When the balance receives a command to control the balance and can not process it, the balance transmits an error code (EC, Exx).
When the balance receives a command to control the balance and can process it, the balance transmits the acknowledge code.
- When a communication error has occurred due to external noise, or a parity error has occurred due to transmission error, the balance transmits an error code. In this case, send the command again.

Among commands to control the balance, the following transmit the acknowledge code both when the balance receives the command and when the balance has accomplished the command. If the command can not be processed properly, the balance transmits an error code (EC, Exx). This error can be released using the CAL command.

CAL command (Calibration command) ON command (Display ON command)

P command (Display ON/OFF command) R command (RE-ZERO command)

TR command (Tare command)

18-3 Command Examples

ON command

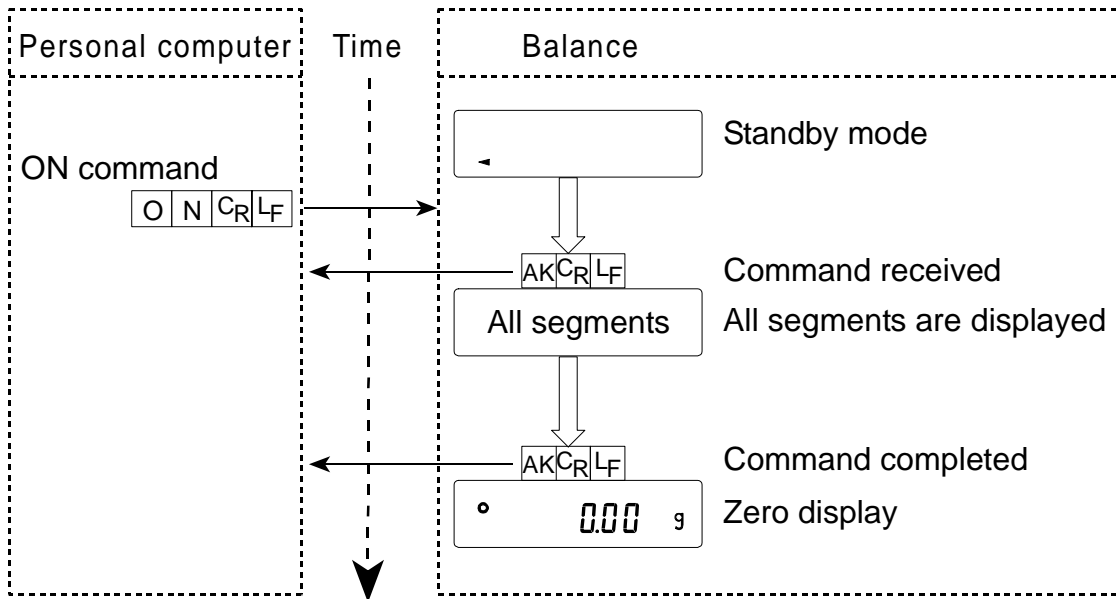

R command

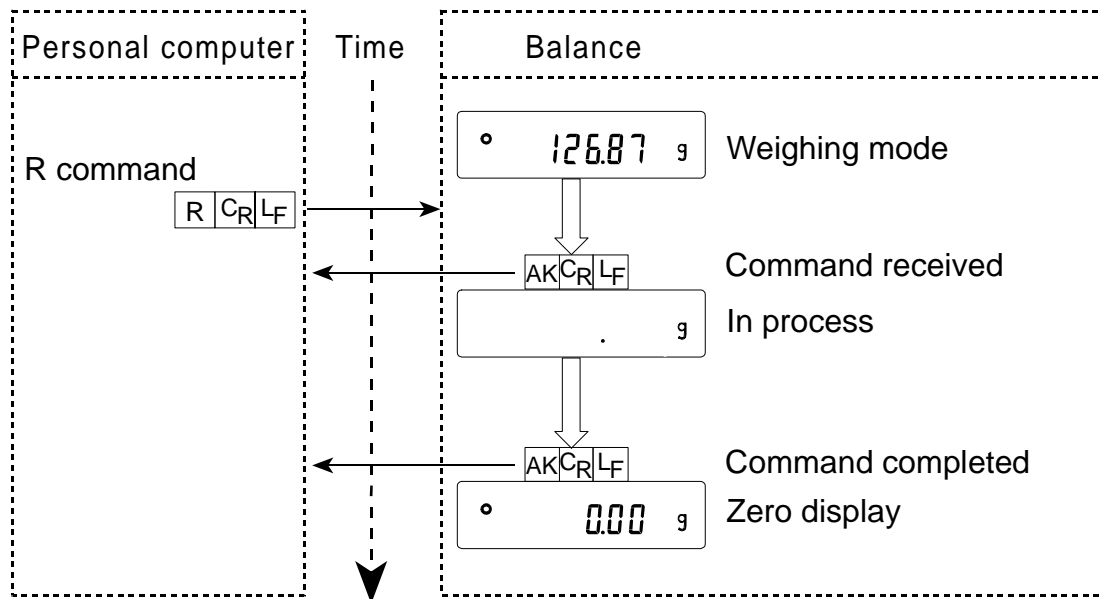

Error code

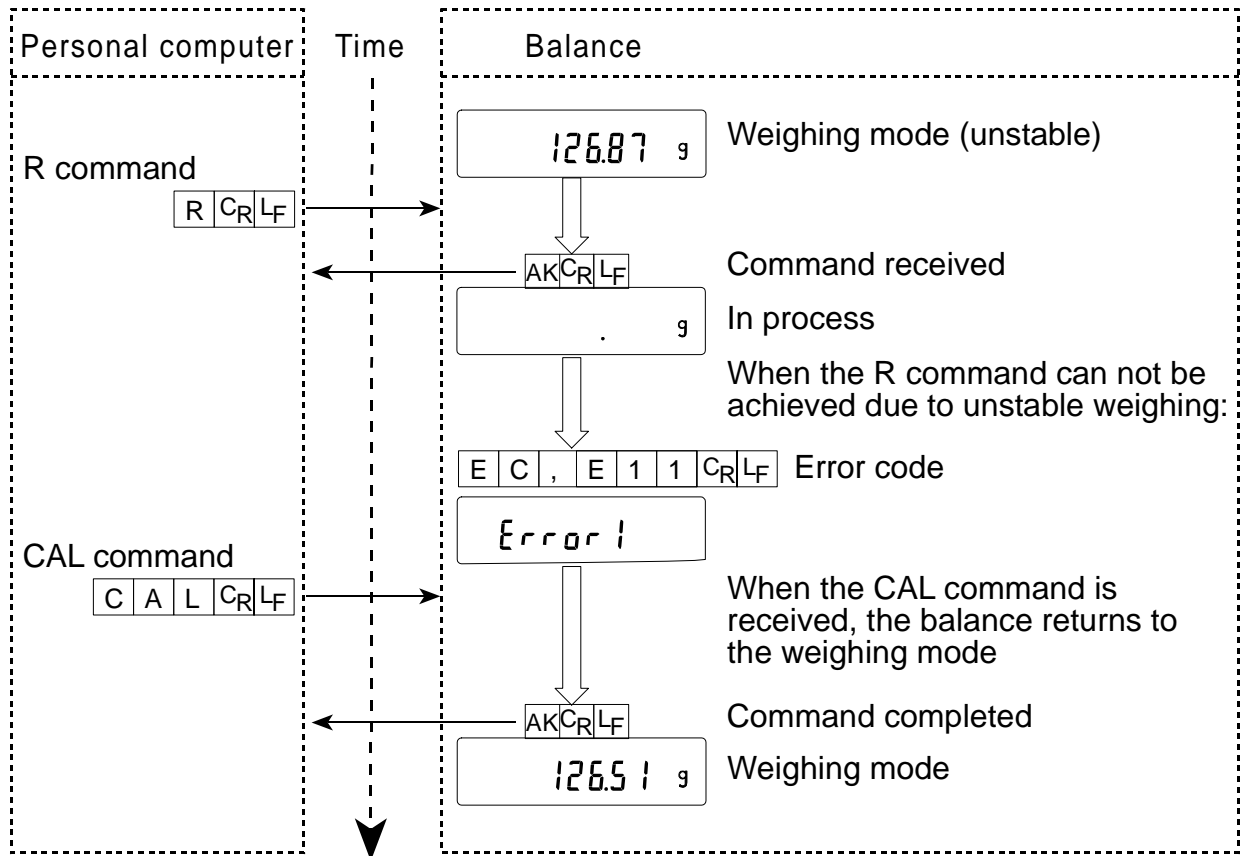

Weighing with a tare

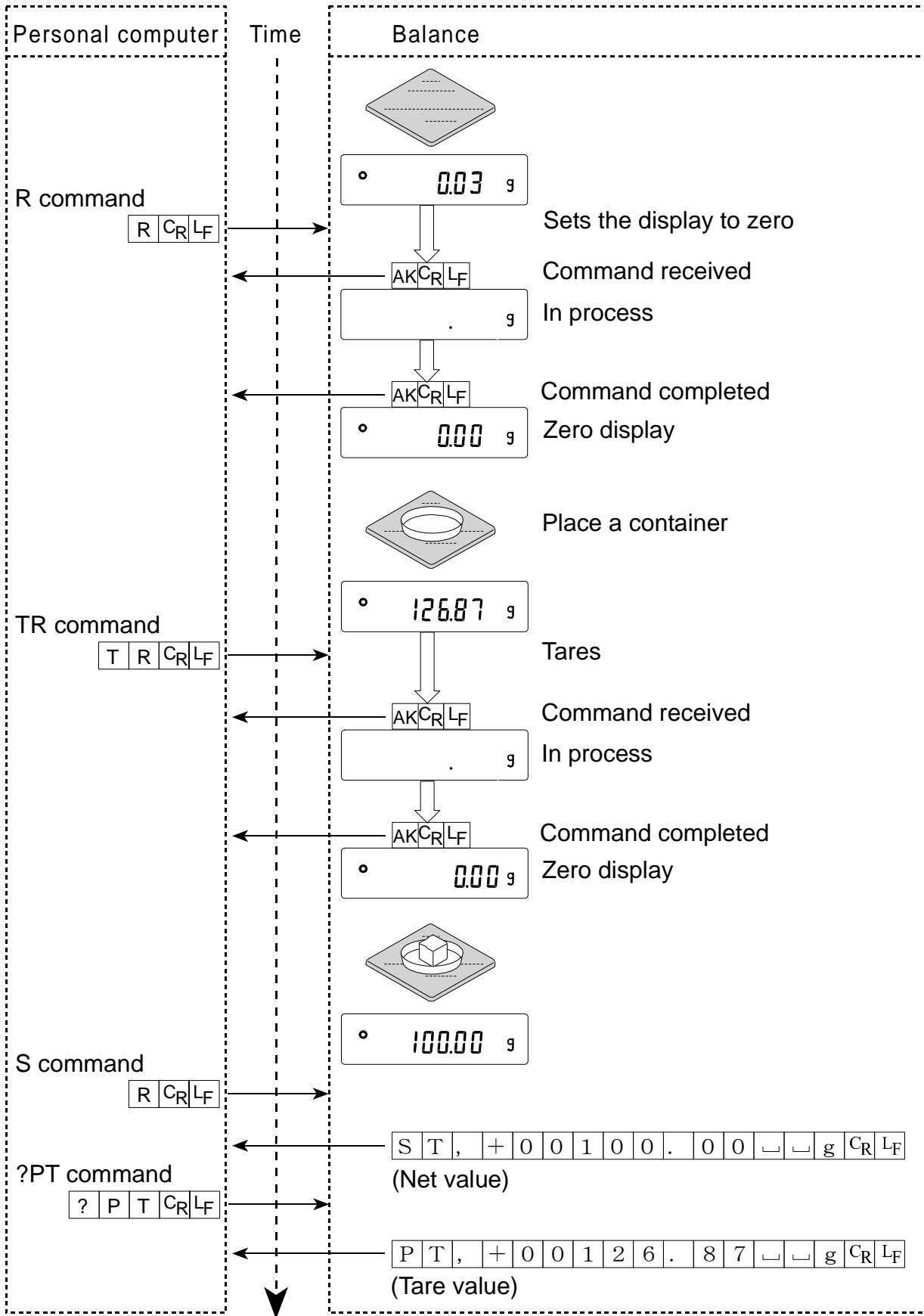

Setting a negative target value and filling with a sample until the display becomes zero

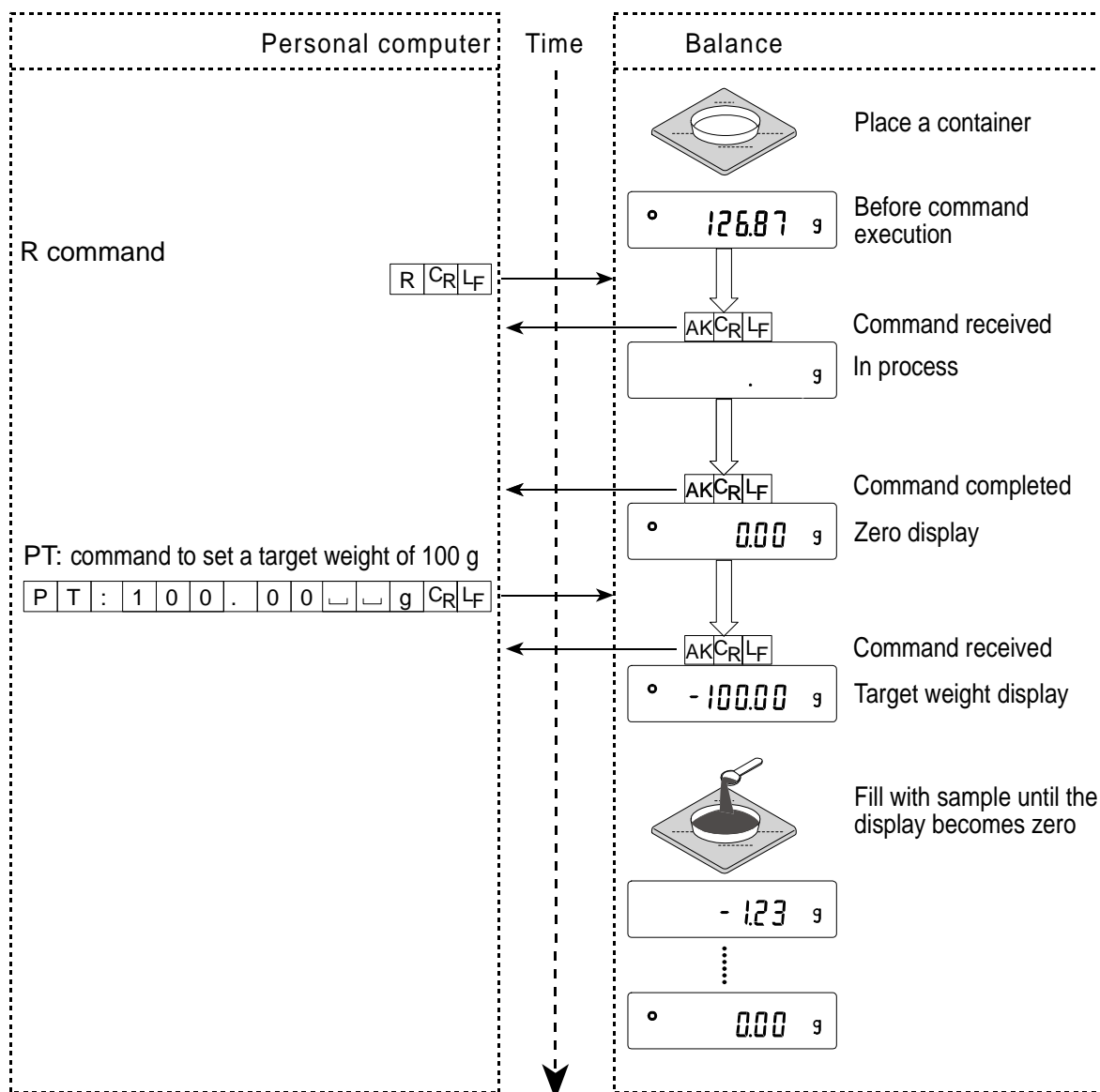

18-4 Control Using CTS and RTS

Depending on the “`CTS`” parameter of “Serial interface (`SIF`)”, the balance performs as follows:

`CTS 0`

Regardless of whether the balance can receive a command or not, the balance keeps the CTS line Hi. The balance outputs data regardless of the condition of the RTS line.

`CTS 1`

The CTS line is kept Hi normally. When the balance can not receive the next command (e.g. while the balance is processing last command), the balance sets the CTS line to Lo. The balance confirms the level of the RTS line before outputting a set of data. If the RTS level is Hi, the balance outputs data. If the RTS level is Lo, data is not output (The data is canceled).

18-5 Settings Related to RS-232C

Concerning the RS-232C, the balance has two functions: “Data output (`data`)” and “Serial interface (`SIF`)”. Set each function as necessary.

19. MAINTENANCE

- Do not use organic solvents to clean the balance. Clean the balance with a lint free cloth that is moistened with warm water and a mild detergent.
- Do not disassemble the balance. Contact the local A&D dealer if the balance needs service or repair.
- Use the original packing material for transportation.

20. TROUBLESHOOTING

20-1 Checking the Balance Performance and Environment

The balance is a precision instrument. When the operating environment or the operating method is inadequate, correct weighing can not be performed. Place a sample on the pan and remove it, and repeat this several times. If the balance seems to have a problem with repeatability or to perform improperly, check as described below. If improper performance persists after checking, contact the local A&D dealer for repair.

Checking that the balance performs properly

- Check the balance performance using the self-check function as described in “7-2 Self Check Function”.
An error display appears when a malfunction is found.
- Check the balance repeatability using an external weight. Be sure to place the weight in the center of the weighing pan.
- Check the balance repeatability, linearity and calibrated value using external weights with a known value.

Checking that the operating environment or weighing method is proper

Operating environment

- Is the weighing table solid enough (especially for the GF-200/300/400/600/800/1000, the balance with a minimum weighing value of 0.001 g)?
- Is the balance level? Refer to “3-1 Before Use”.
- Is the operating environment free from vibration and drafts? For the GF-200/300/400/600/800/1000, has the breeze break been installed?
- Is there a strong electrical or magnetic noise source such as a motor near the balance?

Weighing method



- Does the weighing pan touch the breeze ring or anything? Is the weighing pan installed correctly?
- Is the **RE-ZERO** key pressed before placing a sample on the weighing pan?





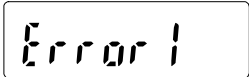

- Is the sample placed in the center of the weighing pan?
- Has the balance been calibrated using an external mass?
- Has the balance been warmed up for 30 minutes before weighing?

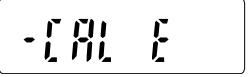
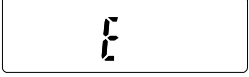
Sample and container

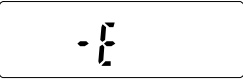
- Has the sample absorbed or lost moisture due to the ambient conditions such as temperature and humidity?
- Has the temperature of the container been allowed to equalize to the ambient temperature? Refer to “3-2 During Use”.
- Is the sample charged with static electricity? Refer to “3-2 During Use”.
The GF-200/300/400/600/800/1000 is prone to be charged with static electricity when the relative humidity is low.
- Is the sample of magnetic material such as iron? Caution is required for weighing magnetic materials. Refer to “3-2 During Use”

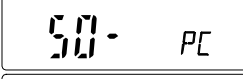
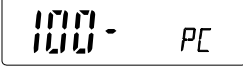
20-2 Error Codes

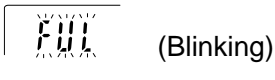
Display	Error code	Description
	EC, E11	Stability error The balance can not stabilize due to an environmental problem. Prevent vibration, drafts, temperature changes, static electricity and magnetic fields. Refer to “3. PRECAUTIONS” for details on the operating environment and “7. RESPONSE ADJUSTMENT” about adapting the balance to the environment. To return to the weighing mode, press the CAL key.
		Out of range error The value entered is beyond the settable range. Re-enter the value.
	EC, E20	Calibration weight error The calibration weight is too heavy. Confirm the calibration weight value. Press the CAL key to return to the weighing mode.
	EC, E21	Calibration weight error The calibration weight is too light. Confirm the calibration weight value. Press the CAL key to return to the weighing mode.
		Overload error A sample beyond the balance weighing capacity has been placed on the pan. Remove the sample from the pan.

Display	Error code	Description
		<p>Weighing pan Error</p> <p>The weight value is too light.</p> <p>Confirm that the weighing pan is properly installed and calibrate the balance.</p>
		<p>Sample mass error</p> <p>The balance can not store the sample for the counting mode or for the percent mode because it is too light.</p> <p>Use a larger sample.</p>
  		<p>Unit mass error</p> <p>The sample unit mass for the counting mode is too light. Storing and using it for counting will cause a counting error.</p> <p>Add samples to reach the specified number and press the PRINT key.</p> <p>Pressing the PRINT key without adding samples will shift the balance to the counting mode. But, for accurate counting, be sure to add samples.</p>
 <p>(CHECK NO)</p>		<p>Internal error</p> <p>Indicates an internal error as the result of self-check function.</p> <p>Repair is required. Contact the local A&D dealer.</p>
		<p>Memory full</p> <p>The amount of weighing data in memory has reached the maximum capacity.</p> <p>Delete data in memory to store new data. For details, refer to "12. DATA MEMORY".</p>
		<p>Memory type error</p> <p>Type of memory set in the function table and type of data stored are different.</p> <p>For details, refer to "12. DATA MEMORY".</p>
	EC, E00	<p>Communications error</p> <p>A protocol error occurred in communications.</p> <p>Confirm the format, baud rate and parity.</p>
	EC, E01	<p>Undefined command error</p> <p>An undefined command was received.</p> <p>Confirm the command.</p>
	EC, E02	<p>Not ready</p> <p>A received command can not be processed.</p> <p>e.g. The balance received a Q command, but not in the weighing mode.</p> <p>e.g. The balance received a Q command while processing a RE-ZERO command.</p> <p>Adjust the delay time to transmit a command.</p>

Display	Error code	Description
	EC, E03	Timeout error If the timeout parameter is set to “ <i>L-UP 1</i> ”, the balance did not receive the next character of a command within the time limit of one second. Confirm the communication.
	EC, E04	Excess characters error The balance received excessive characters in a command. Confirm the command.
	EC, E06	Format error A command includes incorrect data. e.g. The data is numerically incorrect. Confirm the command.
	EC, E07	Parameter setting error The received data exceeds the range that the balance can accept. Confirm the parameter range of the command.
Other errors		If the errors described above can not be released or other errors are displayed, contact the local A&D dealer.

20-3 Asking For Repair

If the balance needs service or repair, contact the local A&D dealer.

The balance is a precision instrument. Use much care when handling the balance and observe the following when transporting the balance.

- Use the original packing material.
- Remove the weighing pan from the main unit

21. SPECIFICATIONS

		GF-200	GF-300	GF-400	GF-600	GF-800	GF-1000
Weighing capacity		210 g	310 g	410 g	610 g	810 g	1100 g
Maximum display		210.084 g	310.084 g	410.084 g	610.084 g	810.084 g	1100.084 g
Minimum weighing value (1 digit)		0.001 g					
Repeatability (Standard deviation)		0.001 g					
Linearity		±0.002 g			±0.003 g		
Stabilization time (typical at FAST)		Approx. 1 second				Approx. 1.5 seconds	
Sensitivity drift (10°C-30°C/50°F-86°F)		±2 ppm/°C					
Operating environment		5°C to 40°C (41°F to 104°F) 85%RH or less (No condensation)					
Display refresh rate		5 times/second or 10 times/second					
Counting mode	Minimum unit mass	0.001 g					
	Number of samples	10, 25, 50 or 100 pieces					
Percent mode	Minimum 100% reference mass	0.100 g					
	Minimum 100% display	0.01%, 0.1%, 1% (Depends on the reference mass stored.)					
External calibration weight		200 g 100 g	300 g 200 g 100 g	400 g 300 g 200 g	600 g 500 g 400 g 300 g 200 g	800 g 700 g 600 g 500 g 400 g 300 g 200 g	1000 g 900 g 800 g 700 g 600 g 500 g 400 g 300 g 200 g
Weighing pan		128 x 128 mm					
Net weight		Approx. 3.8 kg					
External dimensions		210 (W) x 317 (D) x 88 (H) mm					
AC adapter		Confirm that the adapter type is correct for the local voltage and power receptacle type					
Power consumption		Approx. 11VA (supplied to the AC adapter)					
Interface		RS-232C					

	GF-1200	GF-2000	GF-3000	GF-4000	GF-6100	GF-6000	GF-8000
Weighing capacity	1210 g	2100 g	3100 g	4100 g	6100 g	6100 g	8100 g
Maximum display	1210.84 g	2100.84 g	3100.84 g	4100.84 g	6100.84 g	6108.4 g	8108.4 g
Minimum weighing value (1 digit)	0.01 g					0.1 g	
Repeatability (Standard deviation)	0.01 g					0.1 g	
Linearity	±0.02 g				±0.03 g	±0.1 g	
Stabilization time (typical at FAST)	Approx. 1 second				Approx. 1.5 s	Approx. 1 second	
Sensitivity drift (10°C-30°C/50°F-86°F)	±2 ppm/°C					±5 ppm/°C	
Operating environment	5°C to 40°C (41°F to 104°F) 85%RH or less (No condensation)						
Display refresh rate	5 times/second or 10 times/second						
Counting mode	Minimum unit mass	0.01 g				0.1 g	
	Number of samples	10, 25, 50 or 100 pieces					
Percent mode	Minimum 100% reference mass	1.00 g				10.0 g	
	Minimum 100% display	0.01%, 0.1%, 1% (Depends on the reference mass stored.)					
External calibration weight	1000 g 500 g	2000 g 1000 g	3000 g 2000 g 1000 g	4000 g 3000 g 2000 g	6000 g 5000 g 4000 g 3000 g 2000 g	6000 g 5000 g 4000 g 3000 g 2000 g	8000 g 7000 g 6000 g 5000 g 4000 g 3000 g 2000 g
Weighing pan	165 x 165 mm						
Net weight	Approx. 4.3 kg						
External dimensions	210 (W) x 317 (D) x 88 (H) mm						
AC adapter	Confirm that the adapter type is correct for the local voltage and power receptacle type						
Power consumption	Approx. 11VA (supplied to the AC adapter)						
Interface	RS-232C						

22. OPTIONS

Glass Breeze Break (GX-10)

For GF-200/300/400
600/800/1000

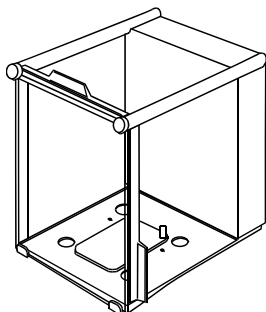

Glass Breeze Break (GX-11)

For GF-1200/2000/3000
4000/6100/6000
8000

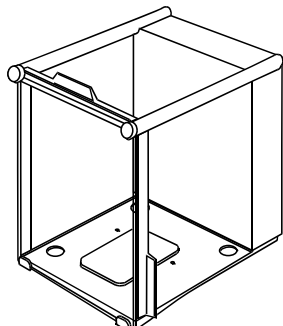

Animal Weighing Bowl Kit (GX-12)

For all models except GF-200
(The mass of the Animal Weighing
Bowl Kit is approx. 200g.)

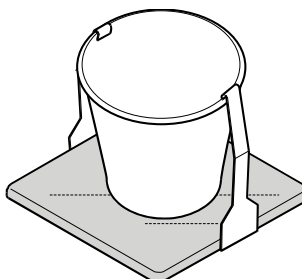

Density Determination Kit (GX-13)

For GF-200/300/400
600/800/1000

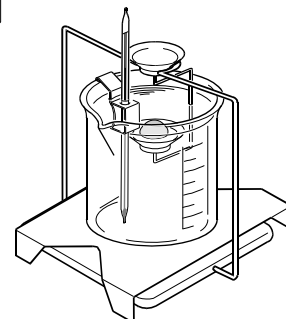

GX-02 USB interface (Applicable OS is Windows 98 OSR2 or later.)

To be installed in place of the RS-232C interface.

- May be used to transmit the balance weighing data to a personal computer.
- The balance weighing data can be transmitted to applications such as Excel, Word and memo pad for Windows automatically.
- Driver installation is not necessary.
- To perform bi-directional communications using WinCT, to output the statistical data or GLP to a personal computer by using the personal computer USB interface, use the AX-USB-25P USB converter.

AD-1682 Rechargeable battery

- Allows use of the balance in a place where AC power is not available.

AD-8121B Printer

- Compact dot-matrix printer
- Statistical function, clock and calendar function, interval print function, graphic print function, dump print mode
- 5 x 7 dots, 16 characters per line
- Print paper (AX-PP143, 45 (W) x 50 (L) mm , ø65 mm)
- AC adapter or alkaline battery.

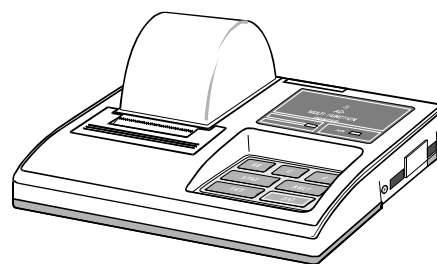

AD-8526 LAN converter

- This option can be used to connect the RS-232C interface of the balance to the Ethernet (LAN) port of a computer. This allows management of the balance weighing data with a computer connected to a network.

AD-8920 Remote display

- Connected to the GF series using the RS-232C interface to display the weighing data away from the balance..

AD-8922 Remote controller

- Connected to the GF series using the RS-232C interface to display the weighing data and to remotely control the balance.

AX-SW128 Foot switch

- Used to externally transmit a RE-ZERO or PRINT signal to the balance.

AX-USB-25P-EX USB converter

- Adds a COM port to a PC.
- Enables bi-directional communication between the PC and the balance when a USB driver is installed.
- Can use serial communication software such as WinCT on a PC without COM ports.
- An RS-232C cable is provided to connect the USB converter to the balance.

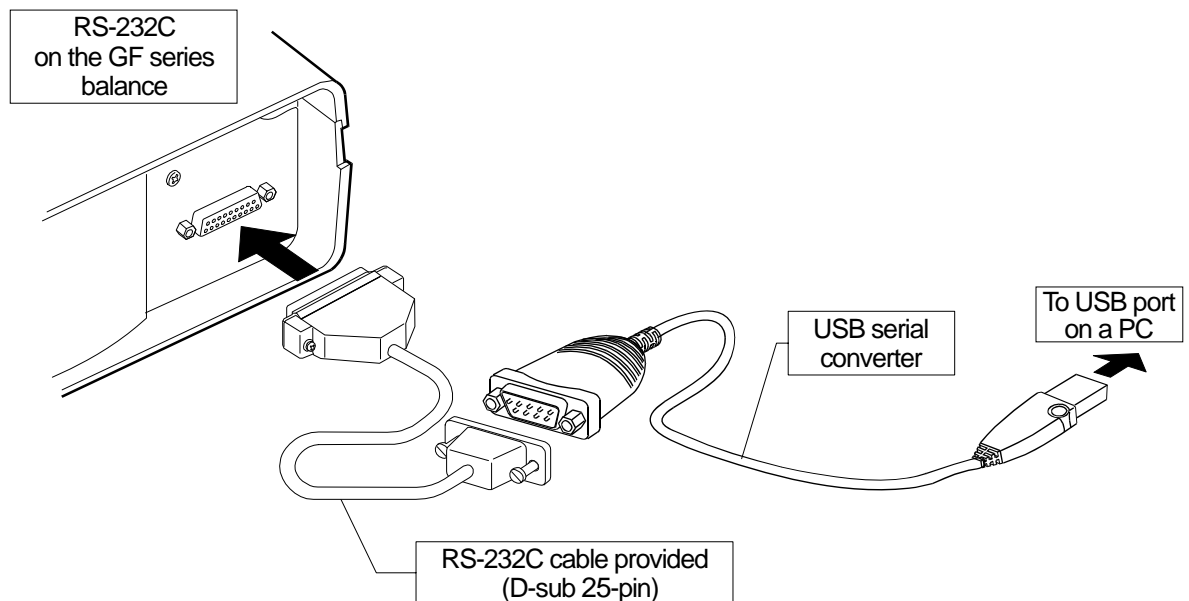

AD-1683 DC static eliminator

- Used to minimize weighing errors due to static electricity on the material.

AD-1684 Electrostatic field meter

- This option measures the amount of the static charge on the sample, tare or peripheral equipment and displays the result.
If those are found to be charged, discharge them using the AD-1683 DC static eliminator.

AD-1689 Tweezers for calibration weight

- This option is used when calibrating the balance using an external weight.

Options installed at the factory before shipment:**GX-04 Comparator output with a buzzer / RS-232C / Current loop output**

- Used to compare weighing data and output the results.

GX-06 Analog output / Current loop output

- Used to output the weighing data as an analog voltage.

23. EXTERNAL DIMENSIONS

GF-200/300/400/600

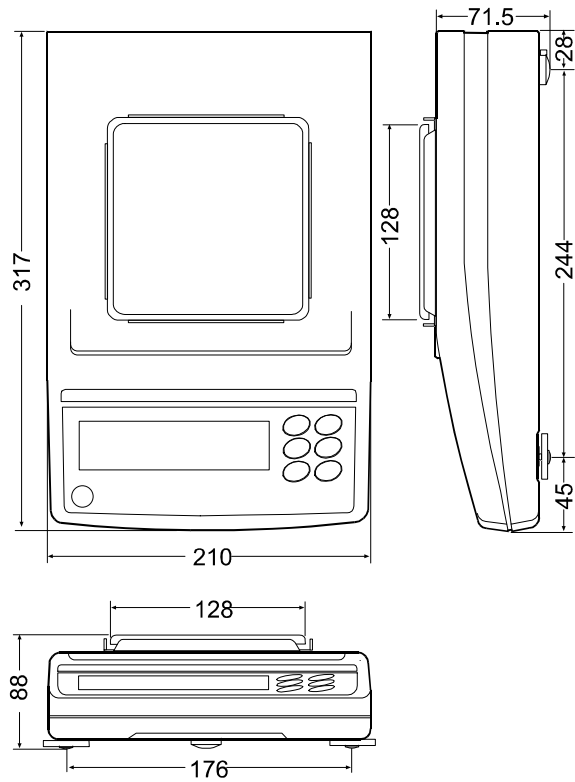

GF-1200/2000/3000/4000/6100/6000/8000

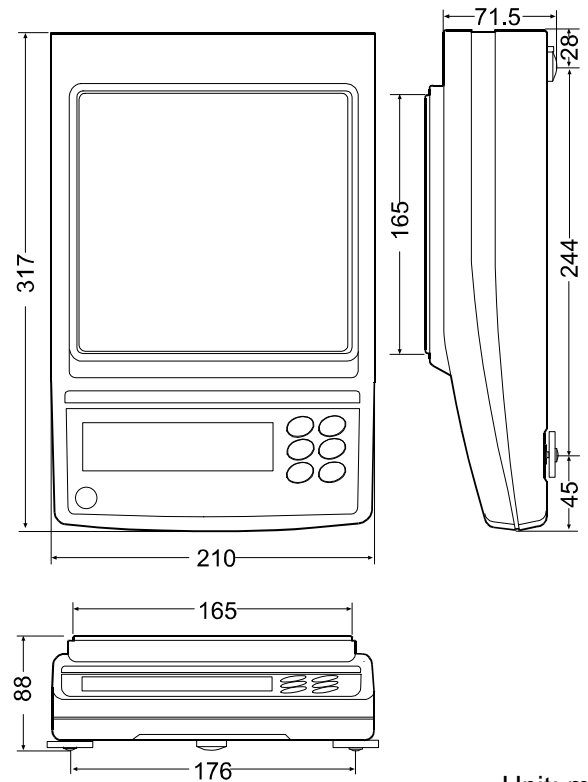

Unit: mm











24. TERMS/INDEX

Terms

Stable value	The weight data when the stabilization indicator appears.
Environment	Ambient conditions such as vibration, drafts, temperature, static electricity and magnetic fields which affect the weighing operation.
Store	To save the weighing data, unit mass or calibration data using the data memory function.
Calibration	Adjustment of the balance so that it can weigh accurately.
Output	To output the weighing data using the RS-232C interface.
Zero point	A weighing reference point or the zero display. Usually refers to the value displayed when nothing is on the weighing pan.
Data number	Numbers assigned sequentially when weighing data or unit weight is stored.
Digit	Unit of digital resolution. Used for the balance, a unit of minimum weighing value.
Tare	To cancel the weight of a container which is not included in the weighing data.
Mode	Balance operational function.
Re-zero	To set the display to zero.
GLP	Good Laboratory Practice.
Repeatability	Variation in measured values obtained when the same weight is placed and removed repetitively. Usually expressed as a standard deviation. e.g. Standard deviation=1 digit: This means that measured values fall within ± 1 digit in the frequency of about 68%.
Stabilization time	Time required after a sample being placed, until the stabilization indicator illuminates and the weighing data is displayed.
Sensitivity drift	An affect that a change in temperature causes to the weighing data. Expressed as temperature coefficient. e.g. Temperature coefficient = 2 ppm/ $^{\circ}$ C : If a load is 300 g and the temperature changes by 10 $^{\circ}$ C, the value displayed changes by the following value. $0.0002\%/^{\circ}$ C x 10 $^{\circ}$ C x 300 g = 6 mg

Index

Keys and symbols

	ON/OFF key	11, 28
	SAMPLE key	11, 15
	MODE key	11, 12, 15
	CAL key	11, 15
	PRINT key	11, 15
	RE-ZERO key	9, 11, 15
	Stabilization indicator	11, 15
	Interval memory active indicator	11
	Interval memory standby indicator	11
	Processing indicator	11

- A -

A&D standard format	37
AC adapter	6, 7
AC adapter ID label	6, 7
AC adapter jack	6, 7
AC adapter plug	6, 7
ACAI	19
AD-1682 Rechargeable battery	74
AD-1683 DC static eliminator	76
AD-1684 Electrostatic field meter	76
AD-1689 Tweezers for calibration weight ...	76
AD-8121B Printer	74
AD-8526 LAN converter	74
AD-8920 Remote display	75
AD-8920 Remote controller	75
Animal mode indicator	11
Auto display-OFF	35
Auto display-ON	35
Auto print mode	36
AX-SW128 Foot switch	75
AX-USB-25P-EX USB converter	75

- B -

Breeze break	3, 7, 9, 68
Breeze ring	7, 68
Bubble spirit level	6, 7

- C -

Calibration	23, 78
Calibration test	26
Capacity indicator	3, 11, 35
Comparator indicators	11
Comparator function	42
CSV format	39

- D -

Data memory	47
-------------------	----

Data number	38, 78
Density determination kit	54
Digit	24, 26, 78
DP (Dump print) format	37

- E -

EC, E00	70
EC, E01	70
EC, E02	70
EC, E03	71
EC, E04	71
EC, E06	71
EC, E07	71
EC, E11	69
EC, E20	69
EC, E21	69
Environment	78
External input	58

- G -

Glass breeze break	74
GLP	3, 44, 78
Grounding terminal	6, 7
GX-02 USB interface	74
GX-04 Comparator output/RS-232C/Current loop output.	76
GX-06 Analog output/Current loop output	76
GX-10 Glass breeze break	74
GX-11 Glass breeze break	74
GX-12 Animal weighing bowl kit	74
GX-13 Density determination kit	74

- H -

Hold function	34
---------------------	----

- I -

ID number	44
Inhibit	28
Initializing the Balance	29
Interval memory mode	37

- K -

Key mode	36
KF format	38

- L -

Leveling foot	374
Linearity	68, 72, 73

- M -

Main unit cover	6, 7
Memory full	48, 70

Mode	78	Sensitivity drift.....	72, 73, 78
MT format	38	Stability band width	34
- N -		Stabilization time	78
NU (Numerical) format.....	38	Stable value	21, 34, 78
- O -		Static electricity	9, 69
Output	78	Store	78
100% reference mass.....	20	Stream mode	36
- p -		- T -	
Pan support receptor	6, 7	Tare	78
Percent Mode	20	- U -	
Permit	28	Underhook	52
- R -		Unit mass.....	18
Reference card	3, 6, 7	Units	12
Repeatability	68, 72, 73, 78	- W -	
<u>RESPONSE</u>	22	Warm up	7,8
Response characteristic	21	Weighing capacity.....	3, 9, 35, 69
Re-zero	78	Weighing pan	6, 7
RS-232C serial interface.....	57	WinCT	3, 60
RsCom	60	- Z -	
RsKey	60	Zero point.....	25, 27, 35, 78
- S -		Zero tracking	35
Self check function	22		



A&D Company, Limited

3-23-14 Higashi-Ikebukuro, Toshima-ku, Tokyo 170-0013, JAPAN
Telephone: [81] (3) 5391-6132 Fax: [81] (3) 5391-6148

A&D ENGINEERING, INC.

1756 Automation Parkway, San Jose, California 95131, U.S.A.
Telephone: [1] (408) 263-5333 Fax: [1] (408) 263-0119

A&D INSTRUMENTS LIMITED

Unit 24/26 Blacklands Way, Abingdon Business Park, Abingdon, Oxfordshire OX14 1DY United Kingdom
Telephone: [44] (1235) 550420 Fax: [44] (1235) 550485

A&D AUSTRALASIA PTY LTD

32 Dew Street, Thebarton, South Australia 5031, AUSTRALIA
Telephone: [61] (8) 8301-8100 Fax: [61] (8) 8352-7409

A&D KOREA Limited

한국에이.엔.디(주)
서울특별시 영등포구 국제금융로6길33 (여의도동) 맨하탄빌딩 817 우편 번호 150-749
(817, Manhattan Bldg., 33. Gukjegeumyung-ro 6-gil, Yeongdeungpo-gu, Seoul, 150-749 Korea)
전화: [82] (2) 780-4101 팩스: [82] (2) 782-4280

ООО A&D RUS

ООО "ЭЙ энд ДИ РУС"
121357, Российская Федерация, г.Москва, ул. Вереysкая, дом 17
(Business-Center "Vereyskaya Plaza-2" 121357, Russian Federation, Moscow, Vereyskaya Street 17)
тел.: [7] (495) 937-33-44 факс: [7] (495) 937-55-66

A&D INSTRUMENTS INDIA PRIVATE LIMITED

ऐ&डी इन्स्ट्रुमेन्ट्स इण्डिया प्रा० लिमिटेड
509, उद्योग विहार, फेस -5, गुडगांव - 122016, हरियाणा, भारत
(509, Udyog Vihar, Phase-V, Gurgaon - 122 016, Haryana, India)
फोन : 91-124-4715555 फैक्स : 91-124-4715599